



LIVE THE LEGEND OF NORWAY

Norway and Svalbard Cruises

2026 | 2027



Signature
VOYAGES

The Svalbard Line
The North Cape Line

Original
VOYAGES

The Coastal Express
The Coastal Express – short voyages

NORWAY— A LIVING LEGEND

Dear curious seafarer,

Welcome to another year of adventure and discovery along the beautiful coast of our magical land, Norway.

Why do we call our land magical? Well, that's quite simple, you just need to look at it and you'll understand. But it goes much deeper. Myths and legends are woven into the very fabric of our land. A mountain might not just be a mountain... shift your perspective a little and it could just as well be a frozen troll.

The Norwegian Sea itself, as legend has it, is personified by the Norse goddess Rán. She was said to have had nine daughters of the sea just as we feel we have 8 daughters of the sea – our ships! Above us, in the dark winter skies, the streaming ribbons of the aurora were said to be a bridge to Valhalla. These are the stories we Norwegians grow up with, stories that shape our connection to the land and sea.

Having served coastal communities since 1893, we like to think that we've taken our place in the evolving story of Norway. That's why we're proud to have been awarded the "Made in Norway" marque, celebrating the best of Norwegian quality and sustainability practices.

So, once again we invite you to join us. Come, take your place in the living legend of Norway,

With adventure ahead,

Hedda Felin
CEO Hurtigruten



THE HURTIGRUTEN DIFFERENCE



TRUSTED SINCE 1893

Over 130 years of knowledge, experience and reliability. We are the original Norwegian voyage, sailing the coast every year, every season, through sun, snow, and storms since 1893. You can trust in our experience to take care of you every step of the way.



CARING FOR THE COAST

Sustaining Norway's coastal communities for generations. We've helped to sustain Norway's coastal communities for generations, caring for people, nature, and livelihoods. In 2023, our ESG report was ranked as best in the world in the cruise category by Sustainalytics. We're also working towards having our first zero-emission ship set sail in 2030.



AUTHENTICALLY NORWEGIAN

Travel like a local as we welcome you to our home. We are proud to be a Norwegian company and many of our Captains and multilingual Expedition Team come from the communities you visit with us. We want to share our passion and knowledge of our home with you.



SMALL-SHIP SAILING

Relax as we take you closer to the beauty of the coast. Our onboard atmosphere is always informal and welcoming, and with only a few hundred guests, you're sure to relax easily. The size of our ships means they're nimble enough to stop at small ports and sail into narrow fjords. It's the ideal balance.



NORWAY'S COASTAL KITCHEN

Award-winning cuisine, sourced where we sail. From hearty reindeer stew and melt-in-the-mouth cod to foraged cloudberries and plant-based delicacies, our award-winning cuisine gives you delicious fjord-to-table dishes and drinks. Eighty percent is sourced from our deep-rooted network of local fisherfolk, farmers, bakers and brewers.



EXPERIENCE NORWAY YOUR WAY

With more sailings, more experiences, more flexibility — every day. Voyage beneath the Midnight Sun. See the Northern Lights. Choose from 2-day to 16-day voyages. Go dog sledding. Spot whales. Explore cities. Visit the vast wilderness of Svalbard. However you want to experience Norway, no one else sails to more places or offers as many unique experiences.







FACTS ABOUT NORWAY

100,000 km of coastline

Second longest coastline in the world

1,700 fjords

50,000 islands

2/3 of the country is mountainous

Warmed by the Gulf Stream

5.5 million population

FACTS ABOUT SVALBARD

Part of Norway

Svalbard is 650 km from the North Pole

Northernmost settlements in the world

Three main islands: Spitsbergen is the largest

Warmed by the last branch of the Gulf Stream

2,500 population

CONTENTS

| | PAGE |
|----------------------------|------|
| Our unique legacy | 6 |
| History of Norway | 8 |
| Our customer reviews | 10 |
| Seasons of inspiration | 12 |
| Northern Lights Promise | 14 |
| Norway's Coastal Kitchen | 16 |
| Expedition Team | 18 |
| Caring of the coast | 20 |
| Sea Zero | 22 |
| Hurtigruten Foundation | 24 |
| Signature Voyages | 26 |
| <i>The Svalbard Line</i> | 34 |
| <i>The North Cape Line</i> | 42 |
| Original Voyages | 56 |
| <i>The Coastal Express</i> | 64 |
| Meet the fleet | 78 |
| Sailing timetable | 94 |
| Terms and Conditions | 96 |

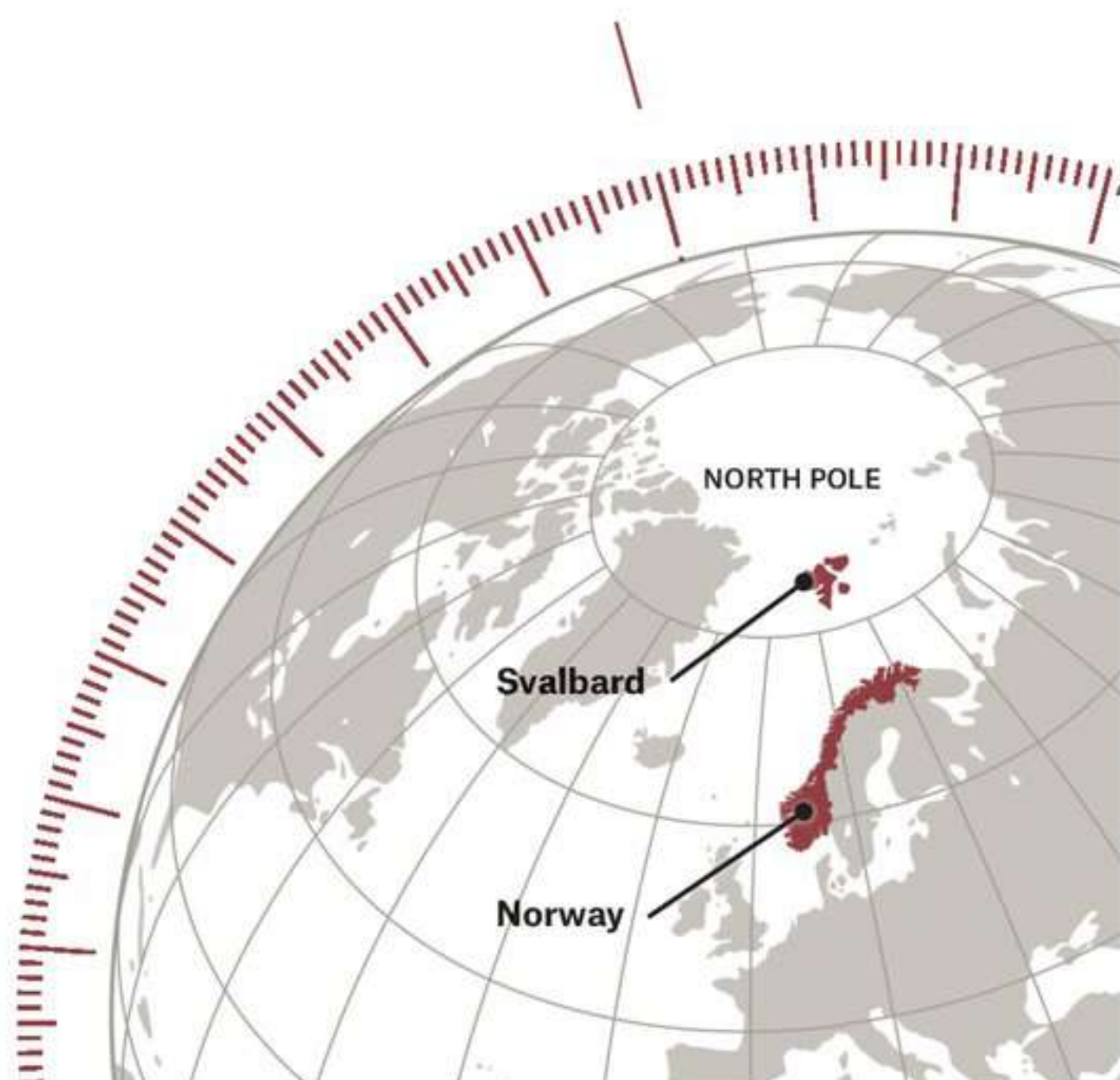

OUR UNIQUE LEGACY

Hurtigruten and our ships are woven into the history of our home for more than 130 years.

Once distant and divided

Before 1893, going from southern Norway to northern Norway or vice versa was a long and difficult journey. Vast mountain ranges stood in the way of roads and railways. And with no single continuous voyage to connect south to north, people had to switch between several smaller ships each time.

In an era of no radar revealing where they were in the dark or in a storm, sailing was unreliable and often dangerous. Just sending a letter from north to south took weeks. A parcel needed months.

A determined visionary

Where others shrank back at the ambition to finally connect the length of the coast, Captain Richard With stepped forward.

Equipped with nautical charts drawn up by experienced local sailor Anders Holte, Captain With carefully prepared a route, schedule, and crew that enabled him to safely sail the coast not just by day, but also in the darkness of night.



Our story together

Changing the coast forever

Captain With's 'Hurtigruten' had its pioneering maiden voyage on 2 July 1893, welcomed at ports by locals who had gathered to cheer and wave in his ship. The day marked the start of a service that would transform life on the Norwegian coast from that moment on.

The fast, safe sailings meant friends, family, lovers, entrepreneurs were no longer cut off, but could now easily move from southern Norway to northern Norway and vice versa.

Goods such as fresh seafood could now be transported south and exported to the world. Likewise, imports and exotic ingredients, like refrigerators and bananas could be brought back to the north, improving the quality of life even high in the Arctic.

Be part of the legacy

Sailing on our ships, you are part of Captain Richard With's vision for the Norwegian coast all those years ago.

This is the history of the communities of the coast. The history of its people and of Norway. We warmly invite you to come and be part of it too.



Hilma Johanna, Narvik

Min del avskjæret

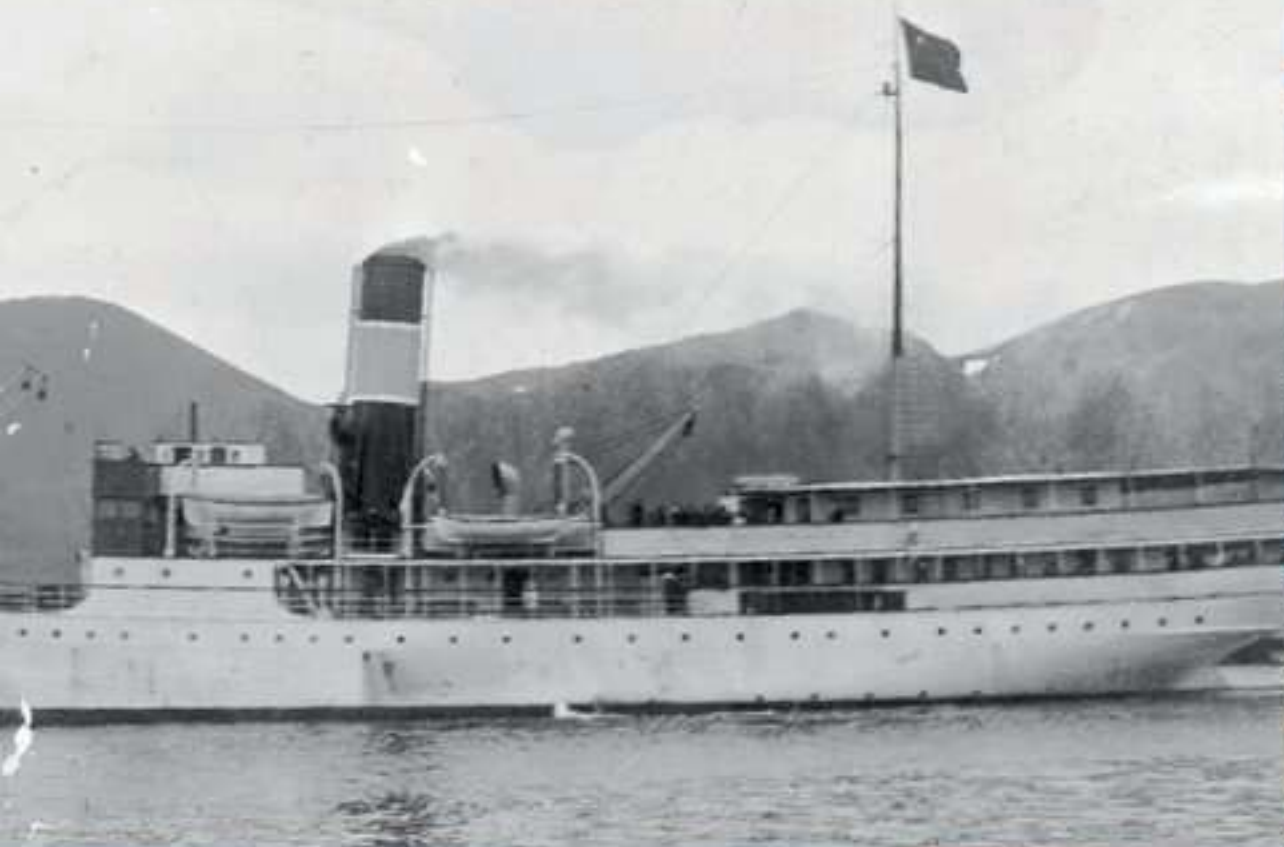

© HURTIGRUTEN; © KNUST HUSTAD / QUEST IMAGE / HURTIGRUTEN; © SHUTTERSTOCK; © HURTIGRUTEMUSEET; © KLAUS PETER KAPPEST / HURTIGRUTEN; © DANIEL ALLEN / QUEST IMAGE / HURTIGRUTEN

SINCE 1893

Our ships have changed a lot since our first steamship in 1893. But our dedication to Norway and its coast has stayed the same.

1893

Our first ever voyage: Captain Richard With sails steamship DS Vesteraalen from Trondheim on 2nd July 1893, arriving in Hammerfest three days later, 45 minutes ahead of schedule.

1898

The route along the Norwegian coast is extended further south and includes Bergen.

1936

The fleet has 14 ships. More than 230,000 passengers, locals, and tourists alike, travel on The Coastal Express each year.

1940-45

700 lives and 14 ships are lost in WWII. New Coastal Express ships after the war are given the highest priority by the Norwegian government.

1983

MS Vesterålen joins the fleet. Named after our first ship DS Vesteraalen, it continues the legacy first began 90 years ago.

1993

Our 100-year anniversary and the construction of MS Kong Harald mark the dawn of the modern era.

2015

Hurtigruten Foundation is established to reinvest in the communities we visit. We also launch the world's only Northern Lights Promise for our autumn, winter, and spring voyages.

2020

MS Lofoten, our longest serving ship, retires to become a training vessel. It had crossed the Arctic Circle 3,500 times and sailed a distance equal to 200 times around the equator.

2022-25

We recently invested €120 million into one of Europe's largest fleet upgrades to reduce emissions, including converting three of our ships to be hybrid-electric.



1908

Kirkenes, at the most eastern point of Norway's coast, becomes the northern turning point of our voyage.

1922

Our ship DS Finnmarken is the first to sail through the Risøyrenna channel as we connect ports in Vesterålen to our route. Norway's King Haakon is on board.

1949-52

Seven ships are added to the fleet. The entire fleet now carries over 500,000 passengers a year.

1968

We begin sailing a route to the town of Longyearbyen on the island of Spitsbergen in the Svalbard archipelago. The Svalbard Line operates every summer until 1982.

2001

MS Lofoten, built in 1964, is declared a national monument by the Norwegian government, a testament to our continued service along the coast.

2011

A six-day voyage on MS Nordnorge is filmed live on Norwegian television across 11 cameras. At over 134 hours, it is the world's longest live broadcast.

2018

Tonnes of single-use plastic items are removed from all our ships. We celebrate our 125-year anniversary with a big, plastic-free party.

2019

We launch our Green Stay for guests to opt out of cabin and linen cleaning, saving fresh water, electricity, and detergent each year.

2021

We begin phasing in sustainable biofuels on our ships.

2022

Our Sea Zero project begins development to build our first emission-free ship by 2030.

2023

We commemorate our 130-year anniversary by launching our Signature voyages: The Svalbard Line and The North Cape Line.

2024

We minimise food waste from our fleet with a compost reactor in Stamsund that turns edible food waste into fertiliser for nearby Myklevik farm to grow new food for us.

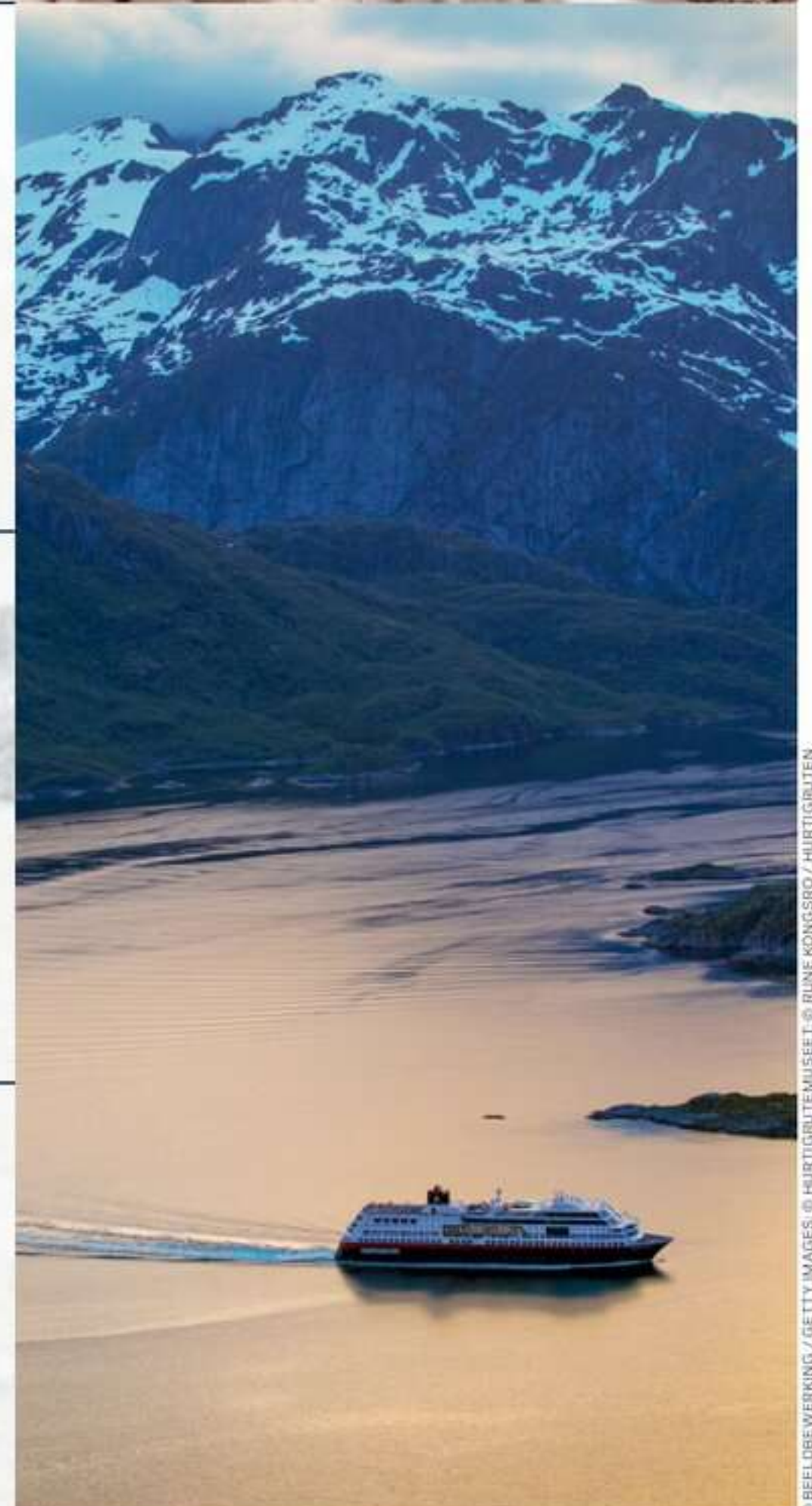
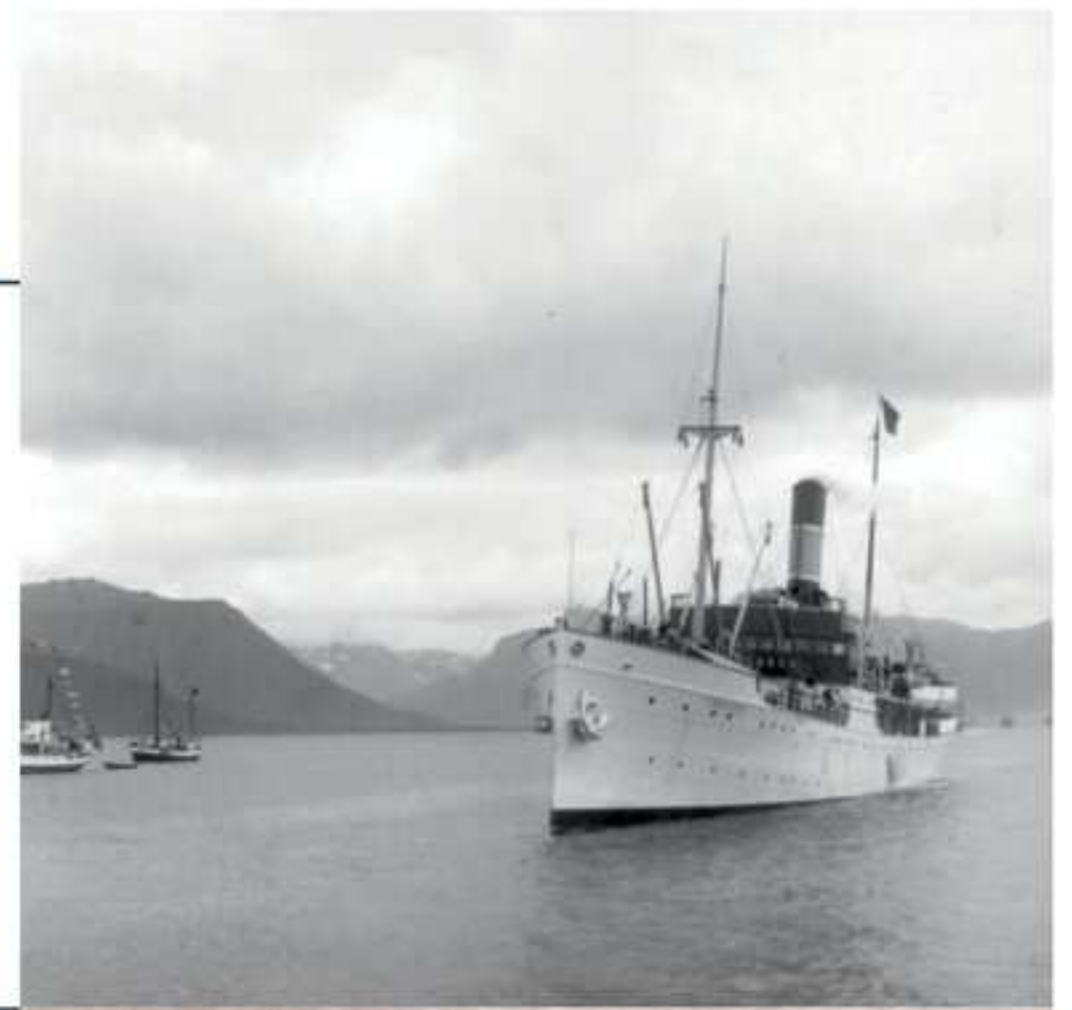

HERE'S WHAT OUR GUESTS ARE SAYING...

feefo

Product Rating



Rated Excellent 4.6/5



Trusted Customer

I've enjoyed a total of five voyages on the northern route and am about to embark on my sixth. The booking process is made easy by patient and resourceful sales staff. The Hurtigruten website provides details of sailings by day throughout the year from which I can submit my choice by email. Replies are usually prompt, helpful and comprehensive. The ships are clean and well managed and the staff friendly. Daily meals are fulsome and plentiful.



George Wishart, Whitley Bay

Very pleased with our cruise. Everything was perfect. Lovely knowledgeable, polite, friendly staff, excellent food. The scenery was wonderful. Highly recommend Hurtigruten.



Marion, Watford

A wonderful experience of snow-capped mountains, brilliant expeditions with huskies and reindeer, wonderful food and relaxing ambience on board. We're doing it again this November!





Janet Rosemary Pope, Havant

A very enjoyable and relaxing experience.
Food very good. Our cabin was lovely.
The crew members were universally friendly and helpful. On board lectures, were interesting and informative, also the excursions that we chose to do were very good.
So overall, an excellent holiday.



Linda Emsley, Sheffield

Had a fantastic 12 day trip organised by Hurtigruten, including flights from UK, which was easy to book on their online site. The food on board was amazing and liked the information given about the local produce used. Lots of cloud so unfortunately didn't see the northern lights as clearly as we had hoped, but as with all things natural, this is to be expected.



Read all our Feefo reviews here

SEASONS OF INSPIRATION

Each season in Norway brings its own special sensations and surprises. Which season will you sail?



Explore Norway in Spring



Reine Village, Lofoten Islands

SPRING | March – May

Sailing the Norwegian coast in spring is like travelling through all four seasons. In the warmer south, admire blossom and birdsong. To the north, you'll enjoy the best of both sunshine and snow. Norwegians even have a specific word for the excitement this season makes us feel: *vårfølelse*, 'springfulness'.

Average temperatures and average daylight hours

| | Temp °C | Hours |
|--------------|-----------|-------|
| Oslo | +3 to +12 | 10-18 |
| Bergen | +5 to +11 | 10-18 |
| Bodø | 0 to +7 | 10-24 |
| Tromsø | -2 to +6 | 10-24 |
| Kirkenes | -6 to +4 | 10-24 |
| Longyearbyen | -1 to -11 | 8-24 |

Wildlife

Birdlife: sea eagles, cormorants, eider ducks

Sealife: humpback, minke whales, harbour porpoises, orcas, Atlantic white-sided dolphins, Atlantic white-beaked dolphins

Important annual events in Norway:

Påske (Easter): March / April

National Day: 17 May

Bergen International Festival: May – June

SUMMER | June – August

Our long summer days are full of outdoor food fairs, flea markets, and festivals. Above the Arctic Circle, enjoy 24 hours of daylight with the Midnight Sun. You'll have more time to embrace the Norwegian concept of *friluftsliv*: exploring nature's turquoise fjords, soaring mountains, and roaring waterfalls that swell with meltwater.

Average temperatures and average daylight hours

| | Temp °C | Hours |
|--------------|------------|-------|
| Oslo | +16 to +18 | 14-18 |
| Bergen | +15 to +16 | 10-18 |
| Bodø | +11 to +14 | 15-24 |
| Tromsø | +9 to +12 | 15-24 |
| Kirkenes | +9 to +12 | 15-24 |
| Longyearbyen | +4 to +8 | 18-24 |

Wildlife

Birdlife: sea eagles, cormorants, eider ducks (with chicks), Arctic terns, skuas, puffins, razorbills, gannets, common guillemots,

Sealife: fin, sei, minke, pilot whales, harbour porpoises, Atlantic white-sided dolphins, Atlantic white-beaked dolphins, common dolphins

Important annual events in Norway:

Sankthans (St. John's): 23 June

Molde Jazz Festival: mid-July



The Midnight Sun



Trondheim



Northern Lights show, Lofoten Islands

AUTUMN | September – October

The summer crowds are gone by the time our forests turn gold, crimson, and copper. The crisp air is ideal for hikes, and we like to pick wild raspberries and cloudberries along the way. It is harvest time too, with many in-season ingredients delivered to our ships as we sail. At night, the aurora reappear among the stars again.

Average temperatures and average daylight hours

| | Temp °C | Hours |
|--------------|-----------|-------|
| Oslo | +7 to +13 | 9-14 |
| Bergen | +9 to +13 | 9-14 |
| Bodø | +6 to +10 | 7-15 |
| Tromsø | +3 to +8 | 7-15 |
| Kirkenes | +1 to +7 | 7-15 |
| Longyearbyen | -2 to +3 | 0-18 |

Wildlife

Birdlife: sea eagles, cormorants, eider ducks

Sealife: humpback, fin, minke whales, harbour porpoises, Atlantic white-sided dolphins, Atlantic white-beaked dolphins, orcas (late autumn)

Important annual events in Norway:

Trondheim Chamber Music Festival: end of September
Høstferie (autumn holiday) / *potetferie* (potato holiday): beginning of October

WINTER | November – February

With blankets of snow coating the mountains and islands, the coast feels wilder and more magical. *Friluftsliv* is as alive as ever as we go skiing, snowmobiling, and snowshoeing. Next to the white landscapes, sunsets are more colourful, and twilight lasts for hours before the Northern Lights stream across the night sky.

Average temperatures and average daylight hours

| | Temp °C | Hours |
|--------------|-----------|-------|
| Oslo | -2 to +3 | 8-10 |
| Bergen | +2 to +6 | 8-10 |
| Bodø | -1 to +3 | 7-10 |
| Tromsø | -3 to -0 | 6-10 |
| Kirkenes | -10 to -4 | 6-10 |
| Longyearbyen | -5 to -9 | 0-8 |

Wildlife

Birdlife: sea eagles, cormorants, eider ducks

Whales: humpback, minke, fin, pilot, sperm whales, orcas, harbour porpoises, Atlantic white-sided dolphins, Atlantic white-beaked dolphins

Important annual events in Norway:

Jul (Christmas): 24 December
Nyttårsaften (New Year's): 31 December
 Sámi National Day: 6 February

10 YEARS

OF OUR FAMOUS

NORTHERN LIGHTS PROMISE

If the Northern Lights don't occur within sight of your ship on a voyage with us of 11 days or more departing between 20 September and 31 March, we'll give you a **free** 6 or 7-day voyage*.

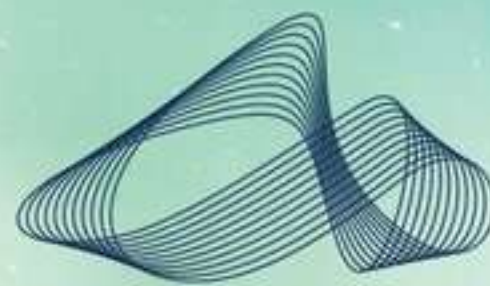

NORTHERN LIGHTS
PROMISE

Terms and conditions apply. Please see page 96 or visit our website for more details.

"It's like real magic happening in front of your eyes. You also get the best of both worlds on the ship. Go out on deck in the Arctic, then go inside and have a cup of coffee straight away."

— Astronomer and our Chief Aurora Chaser, Tom Kerss



Aurora Borealis

The time to see is now

Solar physicist Dr Pål Brekke at the Norwegian Space Agency tell us that the Solar Maximum from 2024 through to 2026 is resulting in 'the most frequent and impressive Northern Lights displays'. The next Solar Maximum isn't for another 11 years. Will you wait that long?

In pole position

Unlike Iceland, northern Norway lies above the Arctic Circle. It is directly under the Auroral Zone, where the lights can appear multiple times in one night.

Your mobile, floating observatory

The crew of our ships are always on the lookout for the lights, meaning you don't have to. This is aurora hunting made as convenient and as comfortable as possible.

Stronger, brighter lights at sea

Being at sea away from the air and light pollution on land means the visibility and vibrancy of the lights are much better. We'll even switch off the lights on the observation deck for you.

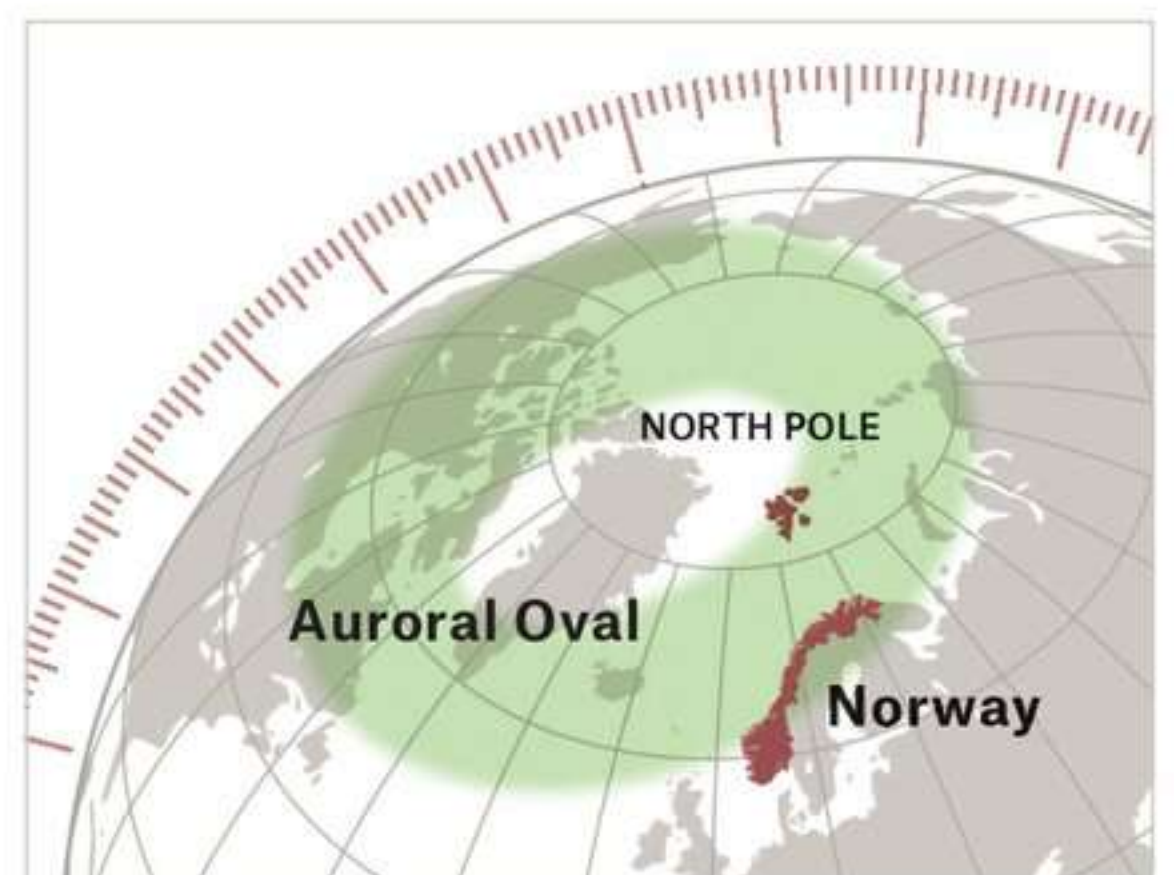

Read more about the Solar Maximum and seeing the Northern Lights from our ships.



CULINARY AMBASSADORS

If the ingredients are 'short-travelled', so is the talent. We've partnered with four top-level professionals who live and work on the Norwegian coast: Head Chef **Astrid Näslander**, Head Chef **Halvar Ellingsen**, Master Mixologist **Halvor Digernes** and **Máret Rávdná Buljo** who is an advocate of Sámi culinary culture.

These Culinary Ambassadors collaborate with our chefs and bartenders to create delicious, sustainable, and locally inspired dishes and drinks that showcase the best of Norway's exciting culinary scene.



NORWAY'S COASTAL KITCHEN

Our ships are floating kitchens, sourcing ingredients where we sail on the bountiful Norwegian coast. The fjords are our fish tanks, the mountains our herb garden.

Fresh, authentic flavours

Over 80% of the in-season food and 60% of the drinks we offer in our menus on board come from 80 local suppliers from all over Norway, delivered direct and fresh-as-can-be to our ships at the ports we sail to.

Showcasing Nordic cuisine on our ships for the past 130 years, no one else has a network of local Norwegian food and drink suppliers like we do, to give you a true taste of Norway.

Food that does good

Choosing homegrown producers means 'short-travelled' food and drink that need a lot less energy on transportation and refrigeration.

We're also able to support a local, circular economy. In fact, 99% of the local drinks suppliers we work with are family-owned businesses.

Towards zero food waste

We have several initiatives to reduce, reuse, and recycle food waste.

One of new projects involves placing food waste from our fleet into a specially designed composter in the port of

Stamsund in the Lofoten islands. Millions of microbes in the composter break down the food waste to create fertiliser.

Nearby, Myklevik farm uses this fertiliser to grow new food for Norway and for our ships. By having our food go from farm to fleet and back to farm, we're able to keep food waste as low as possible.

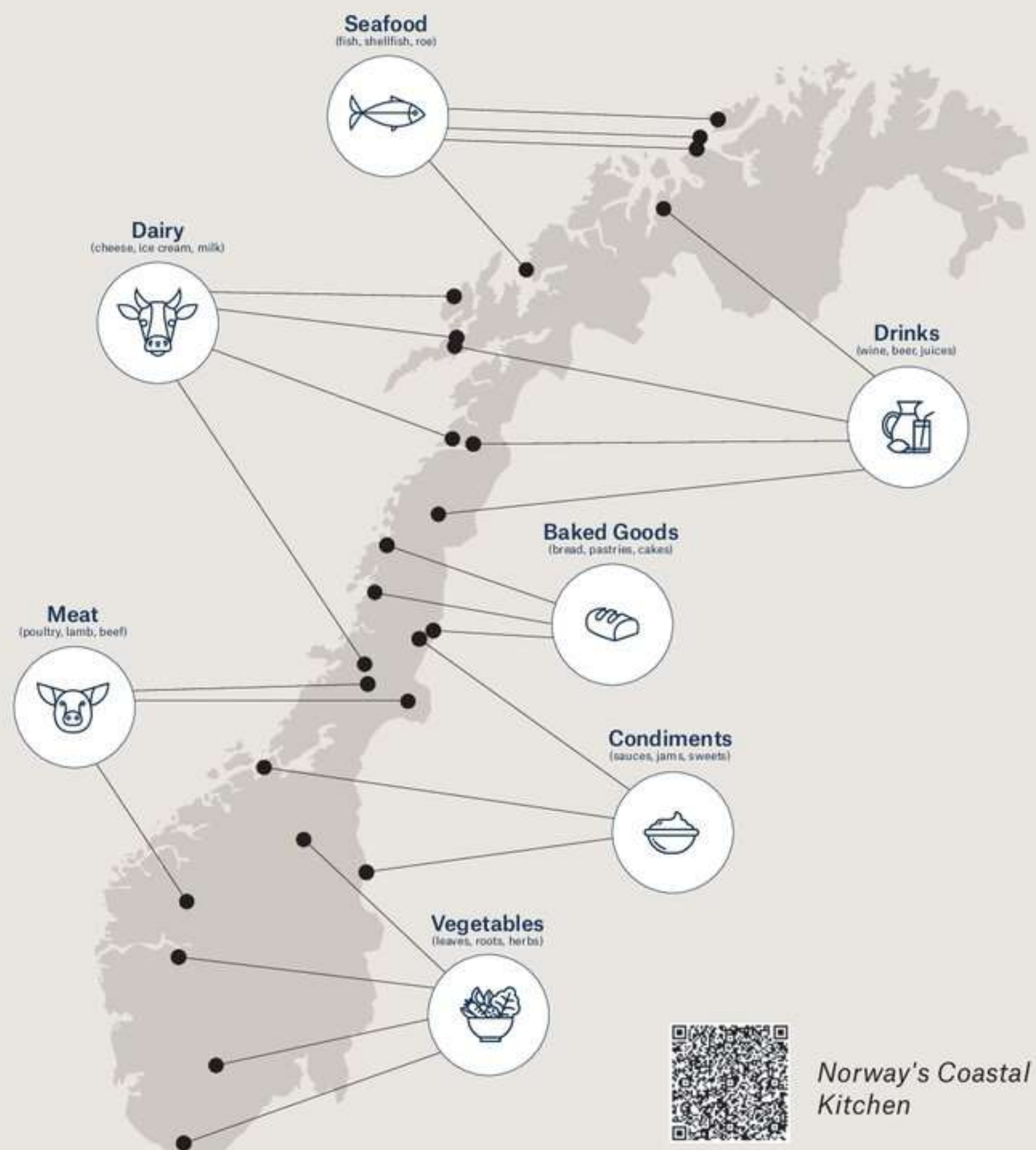

Norway's Coastal Kitchen



"I'm from Trondheim in Norway and have worked aboard Hurtigruten since 2017. I can't imagine any other job! I have family in northern Norway and like to tell stories about them in my lectures."

— Nature & Culture Guide, Hege Børresen

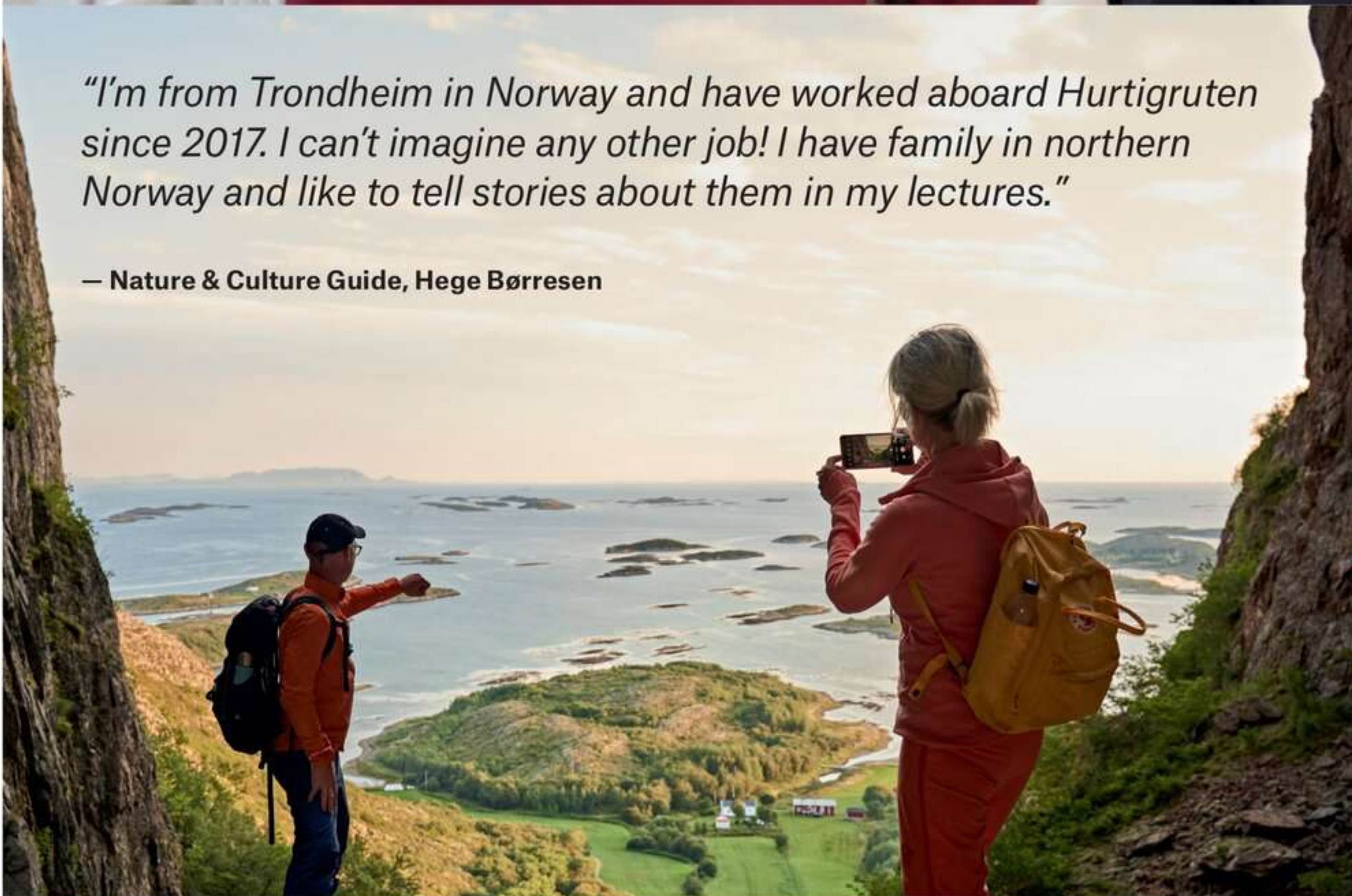



WELCOME TO OUR HOME

The Expedition Team will be right by your side as part of your voyage, sharing insights into the nature, culture, and history that make up the legend of Norway.

Enriching your experience

Enjoy fascinating nuggets of knowledge and stories from the team about Norway in lectures and presentations on board, on deck, and ashore.

Topics range from tips and tricks to photograph the Northern Lights through to old sea shanties and the importance of *friluftsliv* as a quintessential concept in Norwegian culture.

Local perspectives

Many of our Expedition Team members are local Norwegians, born and raised on the coast or elsewhere in Norway. They are eager to share stories of their childhood and family with you.

Other team members may have lived in Norway for several years, perhaps coming from the same country as you. See the coast through their eyes and learn what drew them to now call Norway home.

Quality time with family

Sailing the coast with us is to enter a world of fewer distractions and fewer devices. There's just the natural beauty of Norway unfolding before your eyes. And those of your children or grandchildren.

You'll marvel at the fjords together, watch the Northern Lights in awe, share in the thrill of dogsledding, and follow the Expedition Team on enjoyable hikes to secret mountaintop viewpoints.



© ESPEN MILLS / HURTIGRUTEN; © RAYMOND ENGMARK / HURTIGRUTEN; © KRISTIAN DALE / HURTIGRUTEN

© ESPEN MILLS

CARING FOR THE COAST

We love our home and do all we can to sustain the people, livelihoods, and nature of the Norwegian coast.

MS Nordlys, Geirangerfjord

Caring for people

For many in the north, their first trip in life was with their parents on a Hurtigruten ship going home from hospital as a new-born baby.

Over the decades, we've also carried much-needed cargo home, including cattle, fresh fruit, and medicine. All to build lives and support families.



Learn more about our sustainability initiatives

Caring for livelihoods

Each of our ships provides jobs for a team of mechanics, receptionists, waiters and more. We also make sure to partner with local businesses, whether food and drink suppliers or excursion operators.

As a household name, we are one of Norway's largest maritime apprenticeship organisations, training the nation's next generation of sailors, ship chefs, and engineers.

Caring for nature

We recently invested €120 million into green upgrades, including converting some of our ships to be hybrid-electric. By 2030, we aim to complete Sea Zero: our first zero-emission electric ship.

In 2023, we went into a partnership with Lyngen Seaweed to grow and harvest seaweed, which is a 'blue' superfood and a great source of natural CO₂ capture.



**— Best ESG-ranked —
CRUISE COMPANY IN 2023***

© AGURTXANE CONCELLON



'World's best ESG ranked cruise company' in 2023*



Three hybrid ships to four by 2025



9/9 ships with shore power connectivity



€120million of green upgrades for the fleet



-25% CO₂ and -80% NO_x emissions by 2025



Sustainable biofuels phased in since 2021



No single-use plastics



Zero-emission ship by 2030



80% of our ingredients from local food suppliers



99% of our local drinks suppliers are family-owned



Food waste since 2019-2023: -70%



130+ excursions from local suppliers

SAILING INTO A GREENER FUTURE

SEA ZERO™

We're working towards building the world's most energy-efficient ship of its kind, with a target launch year of 2030.

By making use of the following innovations we anticipate being able to sail completely emissions-free under normal operations, with total energy consumption reduced by up to a half. We're calling our exciting project Sea Zero. There's plenty of exciting research and development work happening so we can expect aspects to evolve, but here are some of the ideas that might be part of our ship for the future:

1. Wind and solar sails

Tiltable, aerodynamic sails with solar panels will help to propel the ship. In the long days of the Norwegian summer, extra photovoltaic energy from the panels will boost power production.

2. Propulsion

The counter-rotating main propellers in the centre and potentially retractable thrusters will save a lot of energy and provide good manoeuvrability when docking.

3. Battery banks

Renewable energy will be stored in the ship's large batteries, currently planned with a capacity of 60 MWh. They will be charged with shore power from the Norwegian energy grid.

4. Smart cabins

Heating and cooling throughout the ship will be taken care of by intelligent heat exchange pumps. Guests can monitor and control energy use in their cabin through an app.

5. AI-guided bridge

The onboard AI will use dozens of exterior sensors and cameras to aid in manoeuvring. The bridge can be slimmed down to the size of a cockpit to give guests more living and viewing areas.

6. Underwater air lubrication

To further reduce the energy required, a thin layer of bubbles will be projected along the hull of the vessel. This air lubrication reduces the frictional resistance between the ship and the surrounding water, allowing the ship to 'surf' on a bed of air bubbles.

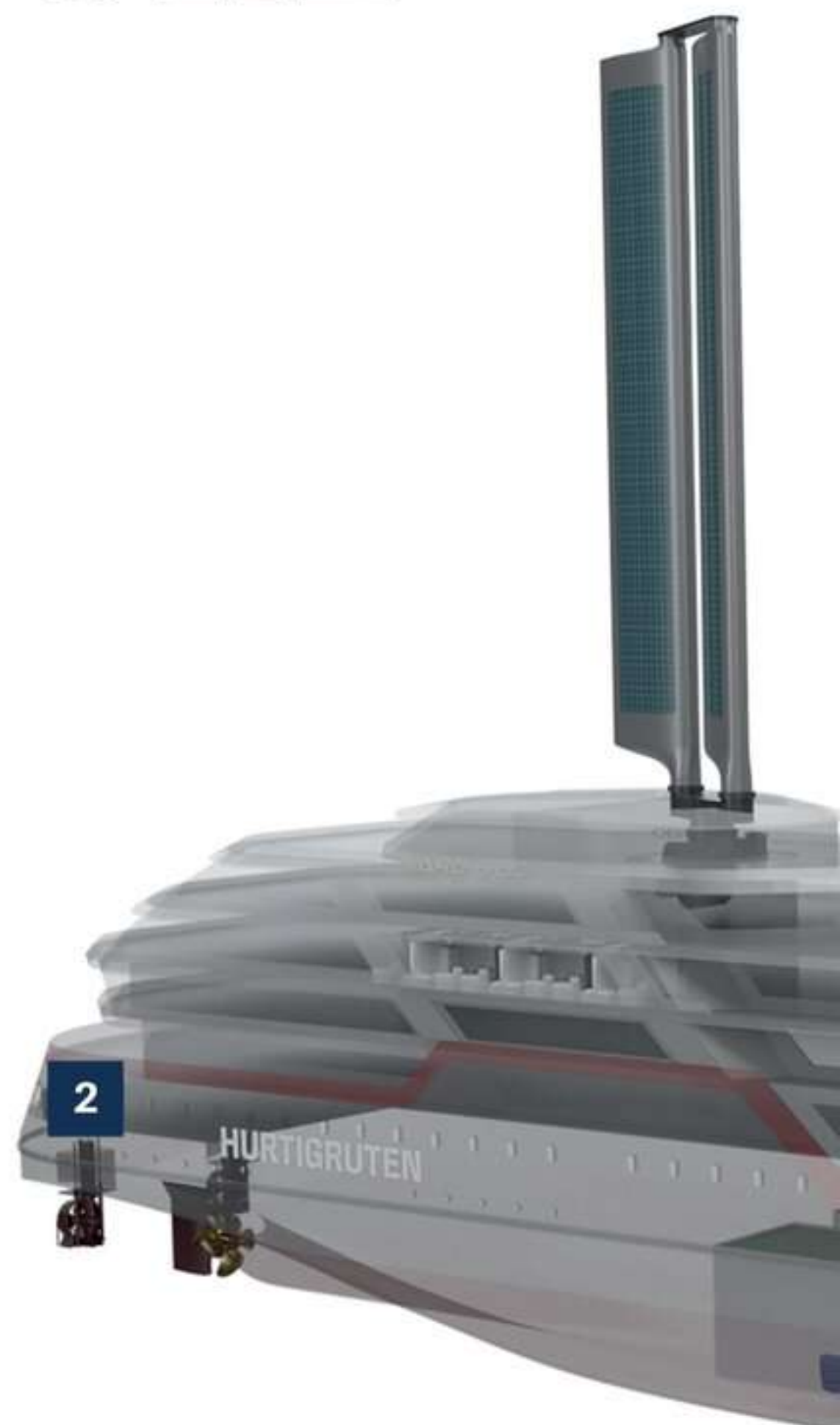

Learn more about
our Sea Zero project



*"The future of cruising?
Norway's Hurtigruten
unveils radical zero-
emission ship design."*

— Forbes Magazine, June 2023



© VARD DESIGN



**Best Concept Ship
Design 2024**

ELECTRIC & HYBRID MARINE AWARDS

HANDS-ON HELP, HERE AND NOW

When you sail with Hurtigruten, you're helping to improve conditions for local people and nature all along the coast.

In 2015 we set up Hurtigruten Foundation with the aim of making a positive impact on the places we sail. Since then, we've supported 99 projects along the coasts of mainland Norway and Svalbard, and every year we select new ones from scores of applicants. By 2024, we had donated 15 million NOK to projects as diverse as cleaning up remote beaches to training search and rescue dogs in Svalbard.

The projects we back align with our stated mission to help coastal communities, combat marine litter and preserve imperilled ecosystems. Once we lend support to an initiative, we don't simply donate and move on, we remain actively engaged with them as we build a relationship. One of the great things about Hurtigruten Foundation is the engagement of our guests. They help us raise funds by participating in

our Green Stay programme, as well as through onboard auctions and via direct donations.

In Norway and Svalbard, between January 2016 and May 2024, Hurtigruten Foundation has, to date:

- supported 99 projects
- donated over €400K





© PETER LEOPOLD. © NORDRE SEILAND BYGDELAG

SOME OF THE PROJECTS WE SUPPORT

We wish we could show you all 99 projects Hurtigruten Foundation have backed in just the last few years, but here's a few of our favourites.

1. Rescue dogs in Svalbard

The Svalbard archipelago is an immense wilderness of snowy mountains and icy tundra. It's no surprise that people sometimes become lost or fall victim to avalanches and other pitfalls. That's why the volunteer search and rescue organisation Norske Redningshunder (Norwegian Rescue Dogs) performs such a vital service for both locals and visitors. We've been supporting them since 2019, with our most recent grant financing a certification course that will enable them to perform hazardous search and rescue missions for the next two years.

2. Clearing up marine litter in Sørøysund

Everyone has heard about the serious and ongoing problem of plastic and other waste entering marine ecosystems. In Sørøysund, northern Norway, the Nordre Seiland rural organisation has been removing litter from shorelines in the area for five years. After the storms of winter, up to 12 tonnes of fresh waste can wash up, which is one reason Hurtigruten Foundation is proud to be donating funds to ensure its continued removal, protecting marine life for generations to come.

3. Helping to rewild our seas

The seabeds around Norway are under attack from invasive sea urchins, decimating the once-vast kelp forests that so much sea life depends upon.

Want to nominate a deserving project?

We're always on the lookout for fresh initiatives that support people and nature in the places we sail to. If you know of one, you can apply for a grant. See our website for more details.

However, 'marine superheroes' Tarevoktere – Guardians of Kelp – are helping reverse this trend with little more than some scuba gear and tools. To date they have restored thousands of square metres of seabed, allowing biodiversity to return. Hurtigruten Foundation has provided Tarevoktere with several grants since 2022, and we're very happy to see such tangible results.



Learn more about the many projects we support.

Signature VOYAGES



Long daytime stops in up to 14 ports for several hours, giving you more time to enjoy unique excursions tailored to you



The best of our award-winning Norway's Coastal Kitchen cuisine across three exceptional onboard restaurants



A generous inclusive drinks package with a wide selection of alcoholic and non-alcoholic beverages



Enhanced onboard activities programme and in-depth lecture series by a larger Expedition Team



Sail with all-inclusive food and drink to our top-handpicked destinations

THE SVALBARD LINE

Sail the coast to the remote Arctic archipelago of Svalbard and the last town before the North Pole.

- Sailing in summer and autumn
- 16 days, 14 ports
- Northbound only: 9 days, 7 ports
- Southbound only: 9 days, 9 ports
- Port calls during the day only
- Average of 5 hours in each port
- 30+ optional summer excursions



THE NORTH CAPE LINE

Your Northern Lights adventure between Oslo and North Cape at the top of Europe.

- Sailing in autumn, winter, spring
- 15 days, 12-13 ports
- Southbound only 9 days, 7-8 ports
- Port calls during the day only
- Average of 6 hours in each port
- 25+ optional seasonal excursions





IN A CLASS OF ITS OWN

Signature voyages are our elevated front-row experiences to Norway's highlights, with premium all-inclusive food and drink and enhanced onboard guiding.



Showing off our favourite places

We've handpicked the destinations on our Signature voyages because we know they'll give you the most enchanting, most breathtaking, and most once-in-a-lifetime discovery of Norway, all on a silver platter.

Take it slow, one port per day

We visit one or two ports each day for several hours at a time. This will give you plenty of time to walk around, join exciting tailored excursions curated by us, and get to know each place like a local.

All-inclusive delicious Nordic cuisine

Our chefs have, as we say in Norwegian, *satt alle kluter til* – 'set the sails to the full' – when

it comes to the exceptional, award-winning food on our Signature voyages.

Twice the experts at your side

We have doubled the number of people on the Expedition Team for our Signature voyages. Benefit even more from hands-on guiding and insights into Norway's nature, culture, and history.

Relax and unwind at sea

Enjoy inclusive activities like landscape painting and photography workshops. You can also de-stress in the fitness room, followed by a soothing sauna session.



Signature
VOYAGES

THE ART OF EXQUISITE CUISINE

Signature
VOYAGES

We take our Norway's Coastal Kitchen all-inclusive food and drink concept to new heights on our Signature voyages.

Flora

The main restaurant, Flora, is inspired by Norway's herbs, berries, mushrooms, flowers, fruit, and vegetables. Enjoy an ever-changing menu of bountiful breakfast and lunch buffets and fixed seating à la carte dinners.

Brasserie Árran

Árran is the northern Sámi word for the fire at the heart of their traditional lavvo tent. This is the place for dishes like reindeer souvas with lingonberry aioli, pickled herring on rye bread with cured egg yolk, and desserts like applewood-smoked cheesecake with sea buckthorn.

Røst

Winner of an international award for 'Best Fine Dining' on a small ship, this restaurant, named after an important fishing area in Lofoten, has exceptional three-to-five course menus that are nothing short of fabulous. All meals and drinks in Røst are included for guests in Suites.

1893 bar

Four different Norwegian beers are on tap, with one of them – an organic IPA named 'Iconic' – made especially for us by Mack Brewery. Or will it be an Arctic Martini, Norgroni, or another of our handmade signature cocktails with a Nordic twist? We say: try all of them. *Skål!*







SAIL IN STYLE



Learn more about
life onboard MS
Trollfjord

The ship of your Signature voyage is a Scandi-chic haven for you to return to after a day's activities in port.

Classic and contemporary

The décor of the 200 or so cabins and the communal areas evoke a sense of nostalgia, calling back to the golden era of small-ship sailing.

Enjoy floor-to-ceiling views from the onboard restaurants, the lounge, and even from the sauna and fitness room.

For fresh sea air and clear views of the fjords, mountains, islands, sunset, or the aurora above, the outdoor observation deck is the place to go.

EXPEDITION SUITES

Our spacious suites are all located on the upper decks and offer you the finest sailing experience with views to match. Expect elegant en-suite bathrooms, no charge for items in the mini bar which is refilled each day, and soft, king-size beds with fine linen.

Suite guests can also take all their meals at fine-dining restaurant Røst, with a wide range of deluxe drinks included.

Owner's Suite

These top-tier suites consist of a lounge area, bedroom, and an en-suite with a bathtub. The added wow-factor is a private balcony from where you can watch the Norwegian coast go by in all its beauty.

Grand Suite

The second largest suite on the ship has a dedicated seating area plus a bedroom with an en-suite. Most have bay windows, some have a bathtub, and a few have private balconies.



Arctic Superior Cabin



Expedition Suite



Polar Outside Cabin

© ESPEN MILLS / HURTIGRUTEN. © AGURTXANE CONCELLON / HURTIGRUTEN

Signature VOYAGES

Suite

These elegant suites come with a seating area as standard, in addition to the bedroom and an en-suite. Most feature a private balcony where you can enjoy the fresh sea air.

Mini Suite

Smaller but by no means less stylish, these suites still sport a luxuriously large king-size bed to sleep and snuggle in. Most have chairs or a sofa to relax on as well.

CABINS

Varying in size, cabins can be found on every deck with en-suite bathrooms. Guests staying in cabins have full-board dining for all three daily meals, including a selection of drinks, at the main restaurant Flora, Brasserie Árran, and 1893 bar.

Arctic Superior

Pure comfort is the hallmark of these cabins. Situated on almost every deck, they all have en-suites with a shower and enjoy views of the coast.

Polar Outside

Our Polar Outside cabins are mostly on the lower decks. All have en-suites with a shower. Most feature a window or small porthole for exterior views.

Some Polar Outside cabins are accessible to guests who require adapted bathrooms and other mobility aids.*

Polar Inside

These are similar in size to Polar Outside cabins, just without the window. Cabins may have twin single beds, one of which converts into a sofa.

*Please note that standard cabins have raised door sills and may not be suitable for larger mobility aids.

VOYAGES

Signature VOYAGES

THE SVALBARD LINE

Sail the coast to the remote Arctic archipelago of Svalbard and the last town before the North Pole.

Sailing in summer and autumn

16 days | 14 ports

Northbound only: 9 days, 7 ports | Southbound only: 9 days, 9 ports

Port calls during the day only | Average of 5 hours in each port

30+ optional summer excursions





We always do our best to keep to our sailing schedule, but sometimes the weather and sea on the Norwegian coast has other plans. When the wind is too wild or the fog is too thick, we change the itinerary and adjust our services with safety in mind. This is part of the experience.

THE SVALBARD LINE

Follow summer's never-setting Midnight Sun along the Norwegian coast and up to the Arctic archipelago of Svalbard at the top of the world.

16
DAYS

Bergen - Longyearbyen - Bergen

14 ports

30+ optional excursions

Departure dates 2026: 11, 25 May, 8, 22 Jun,
6, 20 Jul, 3, 17, 31 Aug

Day 1 | Fly to Bergen

Fly from the UK to Bergen and spend one night in a hotel.

Day 2 | Bergen

If you've time before boarding the ship, browse the boutiques in Bergen's UNESCO-listed Bryggen area and visit the covered fish market.

Approx. departure time: 2:30pm

Day 3 | Åndalsnes

This alpine village is Norway's mountaineering capital thanks to its location at the foot of beautiful mountains along the Isfjord and the Romsdalsfjord.

Approx. time in port: 6 hours

Day 4 | Træna

An archipelago along the Helgeland coast, Træna is home to one of Norway's oldest fishing villages as well as a large population of Sea Eagles.

Approx. time in port: 4 hours

Day 5 | Reine

This 18th-century fishing village of red *rorbuer* below jagged mountain peaks in the Lofoten islands is one of the most photographed landscapes in all of Norway.

Time in port: 6 hours

Day 6 | Tromsø

Tromsø is the historic and modern-day jewel of the Arctic, boasting top restaurants and the iconic iceberg-shaped white Arctic Cathedral.

Approx. time in port: 8 hours

Day 7 | Honningsvåg

Welcome to the gateway to North Cape. At 71°N, it is the famed northernmost point of the European continent, marked by a cliff-top globe monument.

Approx. time in port: 7 hours

Day 8 | At sea

Relax in your ship's panorama lounge or on its large outdoor deck while taking in views of the isolated island of Bjørnøya in the middle of the Barents Sea.



Ny-Ålesund, Svalbard

Day 9 | Longyearbyen

In the morning, we sail Billefjord and see the Nordenskjold glacier before arriving at the Arctic frontier town of Longyearbyen at the top of the world.

Approx. time in port: 6 hours

Day 10 | Ny-Ålesund

We sail to Ny-Ålesund, a climate research centre in a former coal mine town. Then, scan for Svalbard wildlife like reindeer, whales, and walrus in Kongsfjord.

Approx. time in port: 4 hours

Day 11 | At sea

The ship turns south to head back to the Norwegian mainland via the Barents Sea. Enjoy lectures and activities from your Expedition Team.

Day 12 | Torsken

This small fishing village is on the island of Senja, called 'Little Norway' for its varied



landscapes and placed in CNN's ranking of the top ten most beautiful islands in the world.

Time in port: 6 hours

Day 13 | Stokmarknes and Svolvær

First, we head to Stokmarknes, the birthplace of Hurtigruten and home of the Hurtigruten Museum. Next, it's on to Svolvær, a bustling town at the heart of the Lofoten islands.

*Approx. time in port:
Stokmarknes: 2 hours
Svolvær: 4 hours*

Day 14 | Brønnøysund

This stretch of the Norwegian coast, called Helgeland, is known for the UNESCO-listed Vega archipelago and for its

distinctive mountains, like Torghatten, which have inspired local tales of trolls.

Approx. time in port: 4 hours

Day 15 | Ålesund & Sæbø

A quick stop in the Art Nouveau town of Ålesund and we head into the Hjørundfjord in the Sunnmøre Alps. At the heart of the fjord is the peaceful little village of Sæbø.

*Approx. time in port:
Ålesund: 2 hours, Sæbø: 4 hours*

Day 16 | Bergen

You return to Bergen in the morning, bringing back special memories of crossing the Arctic Circle and sailing to the edge of the world in Svalbard.

Approx. arrival time: 7am

INCLUDED

- Return economy flights from London (other UK airports are available for a supplement)
- Transfers to/from ship in Bergen
- One-night stay in a four-star hotel in Bergen city centre, including breakfast
- Transfer from hotel to ship
- 15-day full voyage on The Svalbard Line
- Daily breakfast, lunch, and dinner in the ship's main restaurant Flora
- Daily lunch and dinner in the ship's Brasserie Arran
- Drinks package on the ship with a wide selection of beverages
- Hands-on guiding by the larger onboard Expedition Team
- Onboard activities programme and lecture series

Polar Inside Cabin from **£4,550pp**

Polar Outside Cabin from **£5,132pp**

Arctic Superior Cabin from **£7,264pp**

Expedition Suite from **£10,365pp**

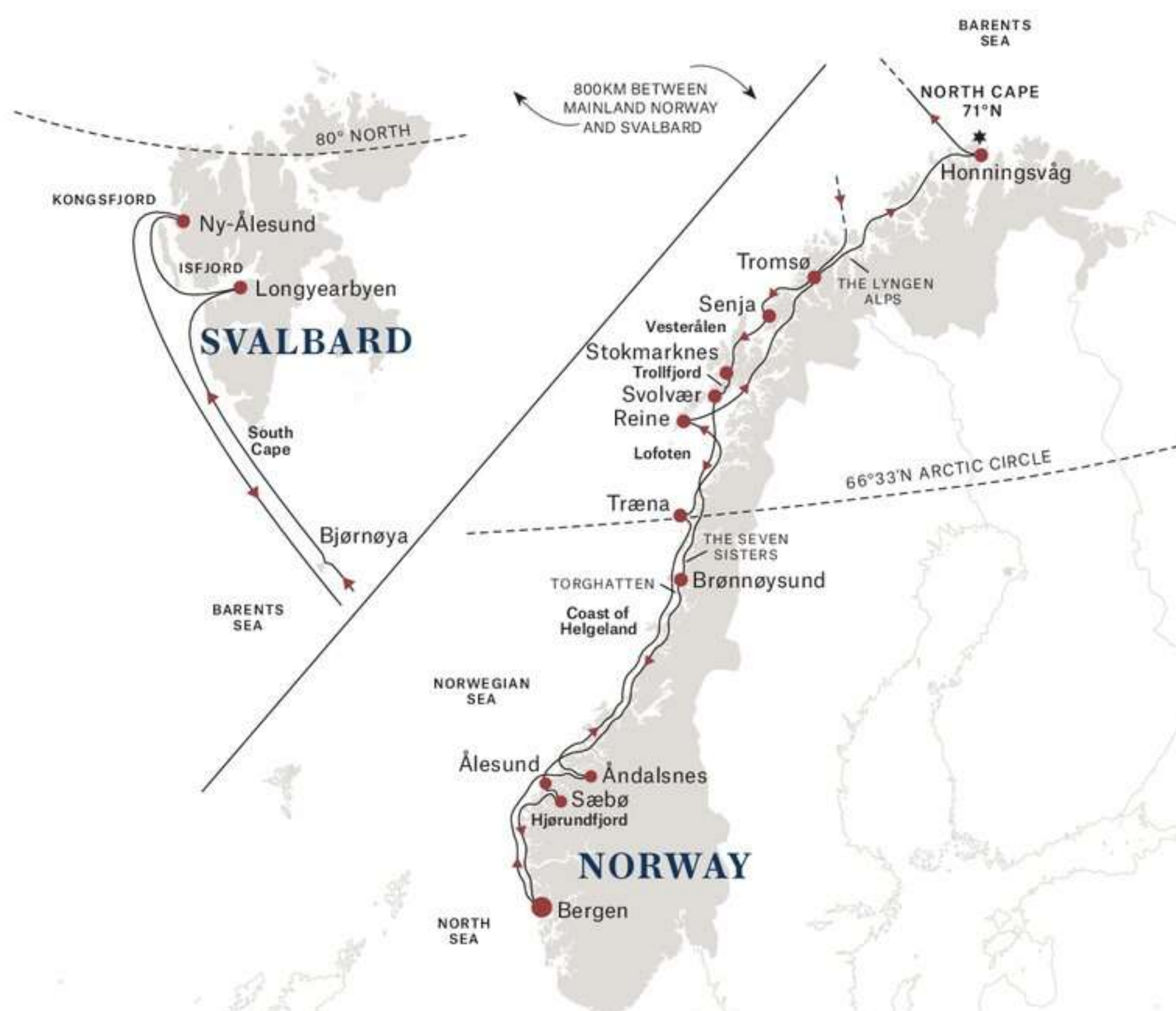

Prefer to make your own flight arrangements? Simply select 'no flights' when you book online or let our Customer Service Team know over the phone.

👤 northbound
👤 southbound



Learn more about
The Svalbard Line

Bergen - Longyearbyen

7 ports

15+ optional excursions

Departure dates 2026:
11, 25 May, 8, 22 Jun, 6, 20 Jul,
3, 17, 31 Aug

9

DAYS

THE SVALBARD LINE-NORTH

The northbound leg of the full voyage is also available as a stand-alone half voyage.

Sail from Bergen, admire the Romsdal mountain valley, and then hug the Helgeland coast in Træna. A highlight on your journey is likely to be Reine, probably the most picturesque fishing village not just in Lofoten but in all of Norway.

After Tromsø and the North Cape, you'll go even further into the Arctic via the isolated island of Bjørnøya. From the open sea, the jagged peaks of Svalbard's mountains appear on the horizon. We dock into frontier town of Longyearbyen via the Isfjord. Welcome to the top of the world.

Itinerary:

- Day 1 | Fly to Bergen
- Day 2 | Bergen
- Day 3 | Åndalsnes
- Day 4 | Træna
- Day 5 | Reine
- Day 6 | Tromsø
- Day 7 | Honningsvåg
- Day 8 | At sea
- Day 9 | Longyearbyen



INCLUDED

- Return economy flights from London (other UK airports are available for a supplement)
- Transfers to/from ship in Bergen/Longyearbyen
- One-night stay in a four-star hotel in Bergen city centre, including breakfast
- Transfer from hotel to ship
- 8-day northbound half voyage on The Svalbard Line
- Daily breakfast, lunch, and dinner in the ship's main restaurant Flora
- Daily lunch and dinner in the ship's Brasserie Årran
- Drinks package on the ship with a wide selection of beverages
- Hands-on guiding by the larger onboard Expedition Team
- Onboard activities programme and lecture series



Longyearbyen, Svalbard

| | |
|----------------------------|-----------------|
| Polar Inside Cabin from | £3,374pp |
| Polar Outside Cabin from | £3,723pp |
| Arctic Superior Cabin from | £5,002pp |
| Expedition Suite from | £6,862pp |



Learn more about
The Svalbard Line
- North

Prefer to make your own flight arrangements?
Simply select 'no flights' when you book online or let our Customer Service Team know over the phone.

Longyearbyen – Bergen

9 ports

15+ optional excursions

Departure dates 2026:
1, 15, 29 June, 13, 27 July,
10, 24 Aug, 7 Sep

9

DAYS

THE SVALBARD LINE – SOUTH

Or start your half voyage from Svalbard and head south to the coast of mainland Norway.

Your journey with us starts from Longyearbyen, the main settlement in Svalbard. From this colourful and surprisingly cosmopolitan town, your ship takes you north to Ny-Ålesund, a former coal mine that has turned into an international science research settlement.

You'll then experience the southbound route of The Svalbard Line, crossing the Barents Sea to mainland Norway. There, you'll explore the idyllic island of Senja, the show-stopping scenery in Lofoten, the Helgeland coast, and the original Ålesund on your way to the city of Bergen.

Itinerary:

Day 1 | Fly to Longyearbyen
Day 2 | Longyearbyen
Day 3 | Ny-Ålesund
Day 4 | At sea
Day 5 | Torsken
Day 6 | Stokmarknes and Svolvær
Day 7 | Brønnøysund
Day 8 | Ålesund and Sæbø
Day 9 | Bergen



Learn more about
The Svalbard Line -
South

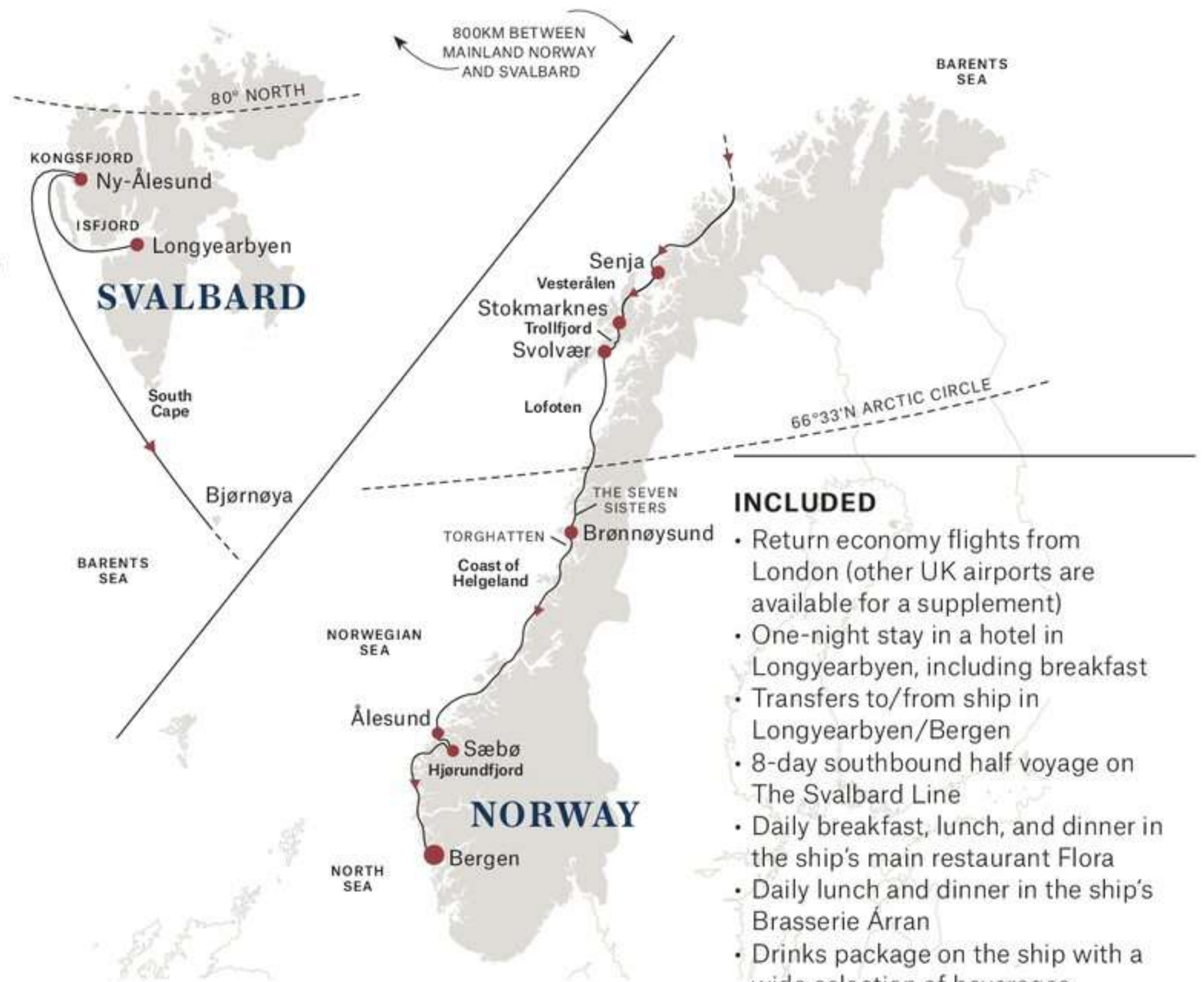

INCLUDED

- Return economy flights from London (other UK airports are available for a supplement)
- One-night stay in a hotel in Longyearbyen, including breakfast
- Transfers to/from ship in Longyearbyen/Bergen
- 8-day southbound half voyage on The Svalbard Line
- Daily breakfast, lunch, and dinner in the ship's main restaurant Flora
- Daily lunch and dinner in the ship's Brasserie Árran
- Drinks package on the ship with a wide selection of beverages
- Hands-on guiding by the larger onboard Expedition Team
- Onboard activities programme and lecture series



Senja

| | |
|----------------------------|-----------------|
| Polar Inside Cabin from | £3,330pp |
| Polar Outside Cabin from | £3,679pp |
| Arctic Superior Cabin from | £4,958pp |
| Expedition Suite from | £6,818pp |

Prefer to make your own flight arrangements?
Simply select 'no flights' when you book online or let our Customer Service Team know over the phone.



The Svalbard Line

EXCURSIONS

Treat yourself to some adventure as we show you the best of Norway and Svalbard. Whether it's learning something new, getting active, or immersing yourself in culture, we have excursions to suit a broad range of interests and ability levels.

Choose from
70+
EXCURSIONS



Trollstigen Scenic Bus Tour



Kayaking



Dogsledding on wheels



RIB Sea Adventure Brønnøysund

CHOOSE YOUR LEVEL

Whether you're into quad biking to the North Cape, or if sedately wandering around a gallery is more your thing, we want everyone to enjoy our optional excursions. That's why we make it easy to choose what's right for you.

Level 1 Easy

Suitable for most

Level 2 Moderate

Some mobility needed

Level 3 Active

Good mobility needed

Level 4 Challenging

Good mobility and fitness needed



Scan to see all our excursions, and to get more information and prices. Please note, excursions can change, and the ones shown on this page are indicative only.

THE SVALBARD LINE EXCURSIONS

| DAY ON RT | BOOKING CODE | EXCURSION NAME | PRICE £ | LEVEL |
|-----------|--------------|---|---------|-------|
| 2 | HRS-AND1 | Åndalsnes Gondola and Town Walk | 154 | 2 |
| 2 | HRS-AND2 | Hairpin bends & Soaring Mountains - Trollstigen | 171 | 1 |
| 2 | HRS-AND3 | Stand-up Paddleboarding in Åndalsnes | 154 | 4 |
| 2 | HRS-AND4 | The Golden Train Summer | 102 | 1 |
| 3 | HRS-TRN1 | Træna Culture Walk - Poetry, Art, and Heritage | 94 | 2 |
| 3 | HRS-TRN2 | Arctic Dip - Sauna & Swim | 111 | 3 |
| 3 | HRS-TRN3 | Træna island Hopping | 283 | 2 |
| 4 | HRS-REI1 | Reine & Lofoten Scenery by Bus | 171 | 2 |
| 4 | HRS-REI2 | Kayaking in Reine | 171 | 4 |
| 5 | HRS-TOS1 | Tromsø, The Arctic Capital | 146 | 1 |
| 5 | HRS-TOS2 | Tromsø On Foot - The City & Its Polar History | 77 | 2 |
| 5 | HRS-TOS3 | Explore Tromsø by E-bike | 154 | 3 |
| 5 | HRS-TOS5 | The Northernmost Brewery | 111 | 2 |
| 6 | HRS-HVG1 | The North Cape | 154 | 1 |
| 6 | HRS-HVG2 | North Cape and King Crab Experience | 240 | 1 |
| 6 | HRS-HVG3 | North Cape and Birdwatching Safari | 257 | 2 |
| 6 | HRS-HVG4 | ATV experience to North Cape | 344 | 4 |
| 6 | HRS-HVG6 | RIB & King Crab Experience | 240 | 3 |
| 8 | HRS-LYR1 | Svalbard Wilderness & History Experience | 137 | 2 |
| 8 | HRS-LYR2 | Dogsledding on wheels | 266 | 3 |
| 8 | HRS-LYR4 | Husky Dog Wagon Ride | 214 | 2 |
| 8 | HRS-LYR5 | Isfjord Safari by open Boat | 133 | 3 |
| 8 | HRS-LYR6 | Longyearbyen by E-bike | 120 | 3 |
| 8 | HRS-LYR7 | Svalbard Hike and fossil Hunt | 120 | 4 |
| 11 | HRS-TOR1 | Senja Scenic Route by Bus | 137 | 1 |
| 11 | HRS-TOR2 | Scenic E-bike Tour of Senja | 137 | 4 |
| 11 | HRS-TOR3 | Senja Wildlife Safari | 223 | 2 |
| 11 | HRS-TOR4 | Fjord Adventure by RIB | 154 | 3 |
| 12 | HRS-SVJ2 | Fishing in Lofoten | 154 | 2 |
| 12 | HRS-SVJ3 | Kayaking in Lofoten | 171 | 4 |
| 12 | HRS-SVJ4 | Lofoten RIB & Sea Eagle Adventure | 137 | 3 |
| 12 | HRS-SVJ5 | Lofoten Scenery & Henningsvær - summer | 128 | 2 |
| 14 | HRS-AES1 | Mountain Peaks & Fjords - A Scenic Bus Tour | 171 | 1 |
| 14 | HRS-AES2 | Ålesund on Foot | 59 | 2 |
| 14 | HRS-SAE2 | Hike in Urke Valley | 111 | 4 |

VOYAGES

Signature VOYAGES

THE NORTH CAPE LINE

Your Northern Lights adventure between Oslo and North Cape at the top of Europe.

- Sailing in autumn, winter, spring
- 15 days | 13 ports
- Southbound only 9 days, 7-8 ports
- Port calls during the day only
- Average of 6 hours in each port
- 25+ optional seasonal excursions





We always do our best to keep to our sailing schedule, but sometimes the weather and sea on the Norwegian coast has other plans. When the wind is too wild or the fog is too thick, we change the itinerary and adjust our services with safety in mind. This is part of the experience.

THE NORTH CAPE LINE

Sail from capital Oslo to North Cape at the top of the European continent, and back, being in awe whenever Norway's Northern Lights appear above.

15
DAYS

Oslo - Honningsvåg - Oslo

13 ports

25+ optional excursions

Departure dates 2026: 25 Sep, 9, 23 Oct, 6 Nov, 18 Dec

Departure dates 2027: 1, 15, 29 Jan, 12, 26 Feb,
12, 26 Mar, 9 Apr

Day 1 | Oslo

What better way to start your Norwegian experience than by exploring the nation's capital? See the iconic iceberg-inspired Opera House and the nearby Munch Museum.

Approx. departure time: 8pm

Day 2 | At sea

Relax and admire the beautiful soft scenery of southern Norway. Start getting to know your shipmates and the Expedition Team.

Day 3 | Lysefjord and Stavanger

We sail through the Lysefjord in the morning, giving you views of the famous Pulpit Rock. Wander around the colourful city of Stavanger, known as the 'Oil Capital of Norway'.

Approx. time in port: 5 hours

Day 4 | Ålesund

This picturesque town at the end of a small peninsula is made even more beautiful by its colourful Art Nouveau architecture. Take in the views from nearby Mount Aksla.

Approx. time in port: 4 hours

Day 5 | Rørvik

Count the 6,000 islands, reefs, and islets that make up the Vikna archipelago around the cosy fishing port of Rørvik. The town is home to the Norveg Coastal Museum.

Approx. time in port: 4 hours

Day 6 | Svolvær and Stokmarknes

Svolvær is the heart of the beautiful Lofoten islands. Stokmarknes in Vesterålen is where we were founded in 1893, and the site of the ship-in-a-bottle Hurtigruten Museum.

Approx. time in port:

Svolvær: 5 hours

Stokmarknes 2 hours

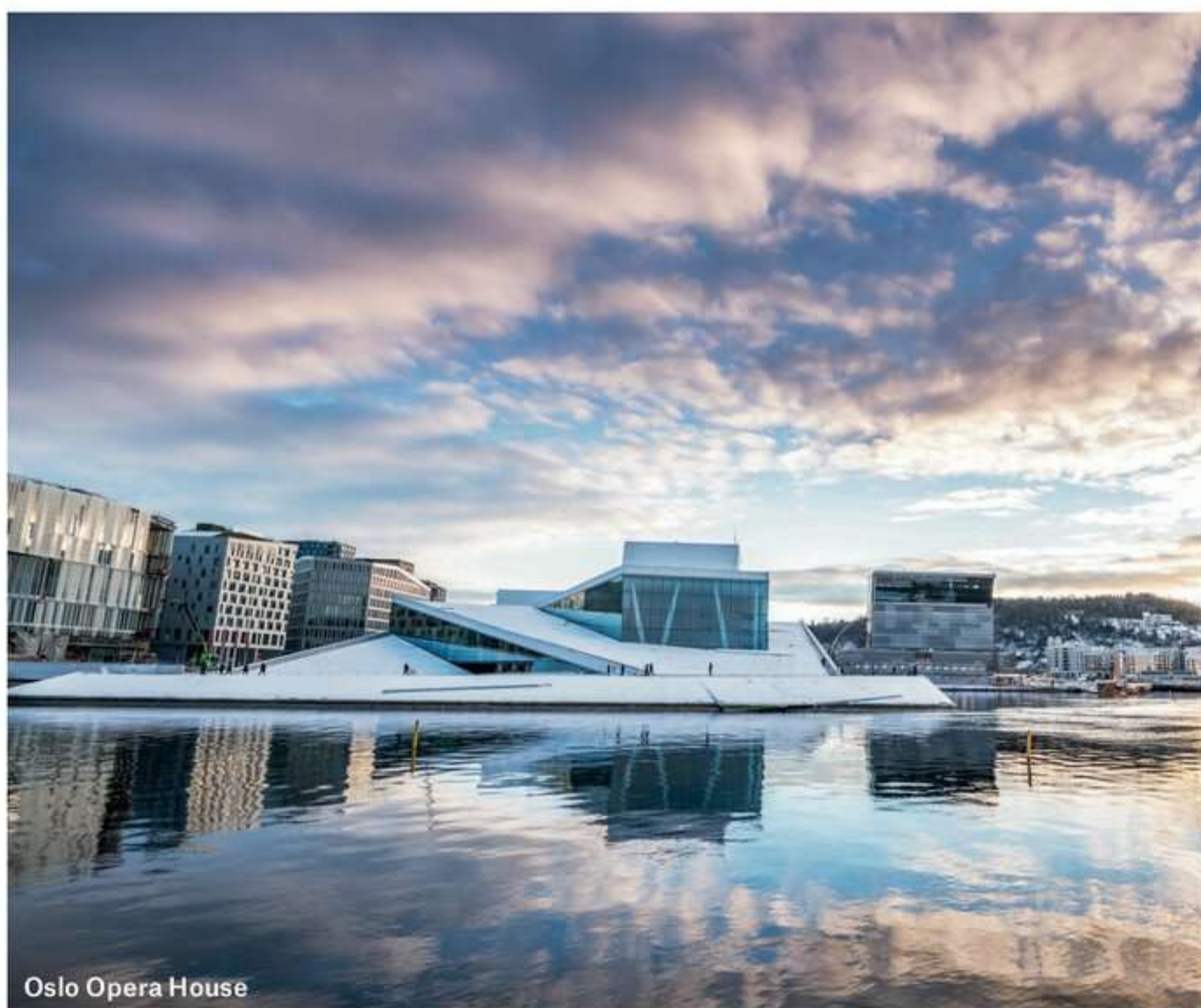

Day 7 | Tromsø

You'll have all day to get to know Tromsø, the historic and modern-day city of the Arctic. It boasts impressive architecture, top restaurants, and a variety of optional excursions.

Approx. time in port: 8 hours



Globe monument, 71°N



Hurtigruten Museum, Stokmarknes

© ESPEN MILLS / HURTIGRUTEN; © FABRIZIO BARDELLI / HURTIGRUTEMUSEET

Day 8 | Honningsvåg

Welcome to the gateway to the North Cape. At 71°N, it is the famed northernmost point of the European continent, marked by a cliff-top globe monument and café.

Approx. time in port: 12 hours

Day 13 | Bergen

'The City of Seven Mountains' is Norway's second largest city. Head to the top of Mount Fløyen via the funicular and browse the shops in the UNESCO Bryggen area.

Approx. time in port: 6 hours

Day 15 | Oslo

You arrive back in Oslo in the morning, bringing back special memories of crossing the Arctic Circle up to the North Cape and hopefully seeing Norway's Northern Lights.

Approx. arrival time: 8am

Day 9 | Alta

Famous for its iconic Northern Lights Cathedral, Alta frequently enjoys clear skies, making it the perfect place for viewing the aurora borealis should they appear.

Approx. time in port: 7 hours

Day 14 | Kristiansand

This city embraces its status as Norway's southernmost city, from the whitewashed walls of Posebyen old town to the fine sand and palm trees of Bystranda urban beach.

Approx. time in port: 4 hours

Day 10 | Narvik

Narvik's position between mountains and fjords makes it a very scenic port town, with also strategic importance during WWII. Take the cable car up to Narvikfjellet for the best views.

Approx. time in port: 5 hours

Day 11 | At sea

The ship has now begun to sail south along the inner coastal route. Relax and admire the scenery from the lounge, keeping an eye out for Sea Eagles and whales.

Day 12 | Åndalsnes

This alpine village is Norway's mountaineering capital thanks to its location at the foot of beautiful mountains along the Isfjord and the Romsdalsfjord.

Approx. time in port: 8 hours



Learn more about
The North Cape
Line

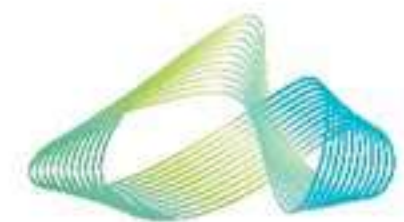

NORTHERN LIGHTS PROMISE

Free 6 or 7-day voyage if the aurora doesn't occur within sight of the ship on voyages of 11 days or more departing between 20 Sep & 31 Mar.*

INCLUDED

- Return economy flights from London (other UK airports are available for a supplement)
- Transfers to/from ship in Oslo
- 15-day full voyage on The North Cape Line
- The original Northern Lights Promise from Hurtigruten
- Daily breakfast, lunch, and dinner in the ship's main restaurant Flora
- Daily lunch and dinner in the ship's Brasserie Árran
- Drinks package on the ship with a wide selection of beverages
- Hands-on guiding by the larger onboard Expedition Team
- Onboard activities programme and lecture series

Polar Inside
Cabin from

£3,379pp

Polar Outside
Cabin from

£3,818pp

Arctic Superior
Cabin from

£5,429pp

Expedition
Suite from

£7,772pp

*Visit our website for terms and conditions.

Prefer to make your own flight arrangements?
Simply select 'no flights' when you book
online or let our Customer Service Team
know over the phone.

THE NORTH CAPE LINE – SOUTH

Start in 'the Arctic capital' of Tromsø, go north to the top of Europe, and then sail south to Bergen and eventually Oslo.

9
DAYS

Tromsø - Oslo

8 ports

12+ optional excursions

Departure dates 2026: 1, 15, 29 Oct, 12 Nov, 24 Dec
Departure dates 2027: 7, 21 Jan, 4, 18 Feb, 4, 18 Mar, 1, 15 Apr

The southbound section of The North Cape Line is split between northern Norway and then western and southern Norway. This means you'll spend the first half of this voyage in the Arctic Circle, increasing your chances of seeing the aurora borealis over four and a half days.

Stand at the top of the European continent at North Cape via Honningsvåg. Drop in to Sorrisniva Ice Hotel in Alta and learn about WWII history in Narvik. Once south, you'll have the scenery of the Romsdal valley beckoning you, and the sights and sounds of Bergen's wharf district and fish market.

Itinerary:

Day 1 | Tromsø
Day 2 | Honningsvåg
Day 3 | Alta
Day 4 | Narvik
Day 5 | At sea
Day 6 | Åndalsnes
Day 7 | Bergen
Day 8 | Kristiansand
Day 9 | Oslo



Aurora Borealis, Tromsø

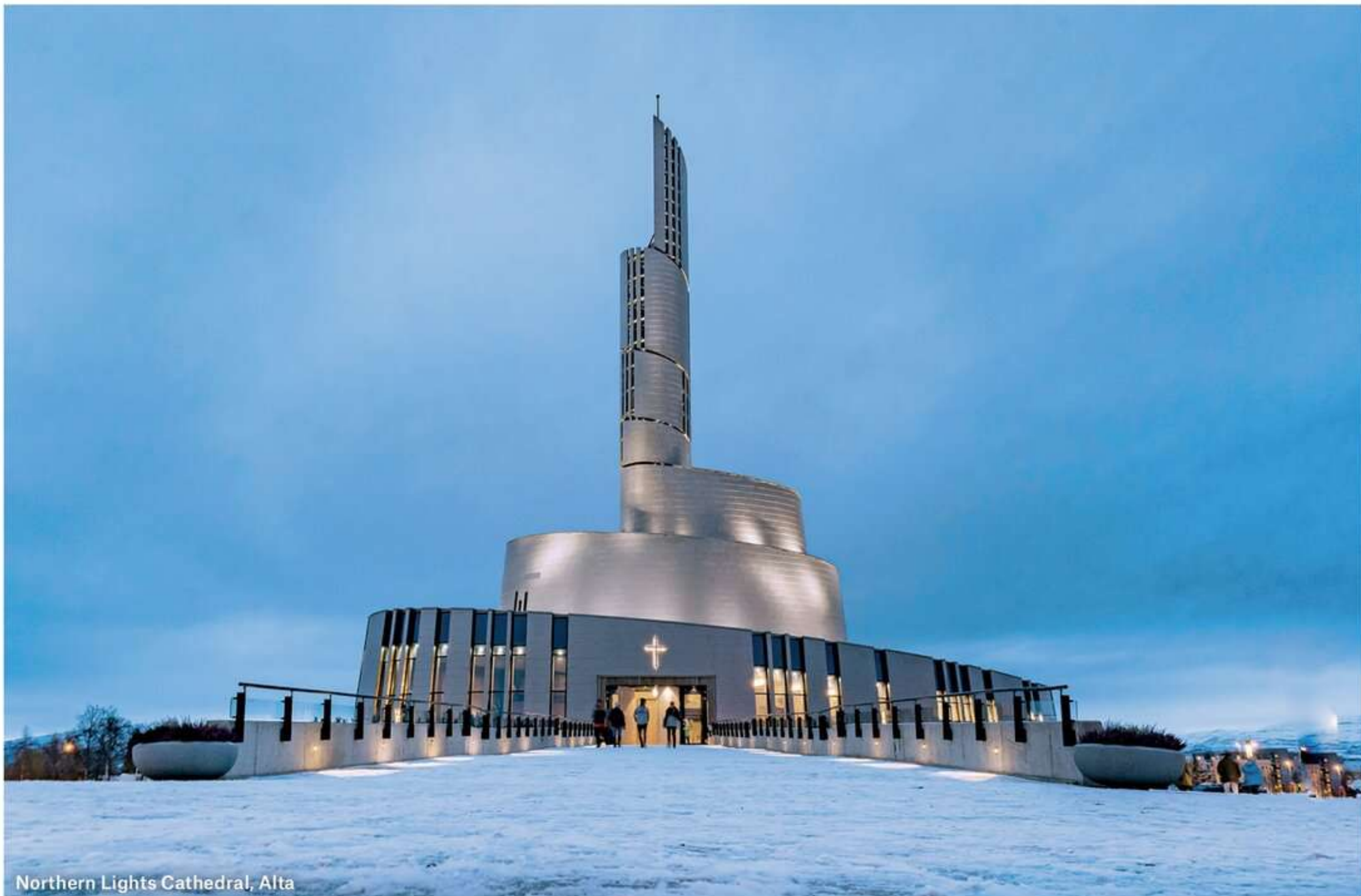

Northern Lights Cathedral, Alta



Learn more about
The North Cape Line
- South

INCLUDED

- Return economy flights from London (other UK airports are available for a supplement)
- Transfers to/from ship in Tromsø and Oslo
- 9-day southbound half voyage on The North Cape Line - South
- Daily breakfast, lunch, and dinner in the ship's main restaurant Flora
- Daily lunch and dinner in the ship's Brasserie Árran
- Drinks package on the ship with a wide selection of beverages
- Hands-on guiding by the larger onboard Expedition Team
- Onboard activities programme and lecture series

| | |
|----------------------------|-----------------|
| Polar Inside Cabin from | £2,816pp |
| Polar Outside Cabin from | £3,137pp |
| Arctic Superior Cabin from | £4,313pp |
| Expedition Suite from | £6,023pp |

Prefer to make your own flight arrangements? Simply select 'no flights' when you book online or let our Customer Service Team know over the phone.



The North Cape Line

EXCURSIONS

Winter in Norway means adventure. Amidst snowy mountains and under the shimmering Northern Lights, experience iconic encounters. From snowshoe walks and husky sled rides to cultural tours and Arctic ice fishing, we've a range of winter activities to suit everyone.

Choose from
70+
EXCURSIONS



Dog Sledding in Winter Wonderland



Kayaking in Lofoten



The North Cape



Visit the Magical Sorrisniva Ice Hotel

CHOOSE YOUR LEVEL

Whether you'd like to try your hand at Arctic fishing, or if gazing at prehistoric rock art in Altafjord is more your thing, we want everyone to enjoy our optional excursions. That's why we make it easy to choose what's right for you.

Level 1 Easy

Suitable for most

Level 2 Moderate

Some mobility needed

Level 3 Active

Good mobility needed

Level 4 Challenging

Good mobility and fitness needed



Scan to see all our excursions, and to get more information and prices. Please note, excursions can change, and the ones shown on this page are indicative only.

THE NORTH CAPE LINE EXCURSIONS

| DAY ON RT | BOOKING CODE | EXCURSION NAME | PRICE £ | LEVEL |
|-----------|--------------|---|---------|-------|
| 3 | HRS-SVG1 | Walking tour in the old town of Stavanger | 68 | 3 |
| 3 | HRS-SVG2 | On the Trails of the Vikings | 94 | 2 |
| 4 | HRS-AES3 | Saga Islands & Alnes Bus Tour | 154 | 2 |
| 4 | HRS-AES4 | Ålesund walk and beer tasting | 77 | 2 |
| 5 | HRS-RVK1 | Timetravel through Rørvik | 68 | 2 |
| 5 | HRS-RVK2 | Nærøya: The Island of the Gods | 206 | 2 |
| 6 | HRS-SVJ1 | Lofoten Scenery & Henningsvær - winter | 128 | 2 |
| 6 | HRS-SVJ2 | Fishing in Lofoten | 154 | 2 |
| 6 | HRS-SVJ3 | Kayaking in Lofoten | 171 | 4 |
| 6 | HRS-SVJ4 | Lofoten RIB & Sea Eagle Adventure | 137 | 3 |
| 7 | HRS-TOS1 | Tromsø, The Arctic Capital | 146 | 1 |
| 7 | HRS-TOS3 | Explore Tromsø by E-bike | 154 | 3 |
| 7 | HRS-TOS6 | Cross-Country-Skiing in Tromsø | 154 | 4 |
| 7 | HRS-TOS8 | Dog Sledding in Winter Wonderland | 292 | 3 |
| 8 | HRS-HVG1 | The North Cape | 154 | 1 |
| 8 | HRS-HVG2 | North Cape and King Crab Experience | 240 | 1 |
| 8 | HRS-HVG4 | ATV experience to North Cape | 344 | 4 |
| 8 | HRS-HVG7 | Arctic Ice Fishing | 292 | 3 |
| 9 | HRS-ALF1 | Dog Sledding in Alta | 292 | 3 |
| 9 | HRS-ALF5 | Visit the Magical Sorrisniva Ice Hotel | 120 | 1 |
| 9 | HRS-ALF6 | UNESCO Rock Art & Northern Lights Cathedral | 146 | 1 |
| 10 | HRS-NVK1 | Wonders of Wildlife at Polar Park | 171 | 3 |
| 10 | HRS-NVK3 | Self-Drive Dogsled Adventure | 292 | 4 |
| 10 | HRS-NVK4 | Sámi Cultural Encounter | 146 | 1 |
| 10 | HRS-NVK5 | Snowshoe Trek with Panoramic Views | 137 | 4 |
| 12 | HRS-AND1 | Åndalsnes Gondola and Town Walk | 154 | 2 |
| 12 | HRS-AND5 | The Golden Train Winter | 56 | 1 |
| 13 | HRS-BGO1 | Bergen City Walk | 68 | 2 |
| 13 | HRS-BGO2 | Discover Bergen by E-Bus | 77 | 1 |
| 14 | HRS-KRS1 | Kristiansand WWII History Tour | 102 | 1 |
| 14 | HRS-KRS2 | Walking Tour of Kristiansand | 42 | 2 |
| 14 | HRS-KRS3 | Norwegian Christmas at Skraastad Farm | 137 | 1 |



Snowshoe Trek



Northern Lights Cathedral, Alta



Bergen City Walk

Signature
VOYAGES

WHAT'S INCLUDED

Our Signature voyages come with a long list of inclusive benefits and possible upgrades.



FOR GUESTS IN CABINS

Enjoy an impressive range of included benefits when you choose from our selection of comfortable options: Polar Inside, Polar Outside, and Arctic Superior cabins.

Accommodation

- Choice of cabin type
- Choice of cabin location ^{FULL VOYAGES ONLY}
- Accommodation in a comfortable cabin with ensuite bathroom

Food and drink

- Daily breakfast, lunch, and dinner in the ship's main restaurant Flora
- Daily lunch and dinner in Brasserie Árran
- Unlimited selected drinks in Flora, Brasserie Árran, and 1893 Bar during opening hours
- Unlimited selected tea and coffee
- Afternoon snack in the bar
- Culinary demonstrations and food tastings
- Local beer tasting

Life on board

- Complimentary Wi-Fi throughout the ship and in your cabin
- Multi-lingual Expedition Team
- Daily themed lectures, photography guidance, arts and crafts sessions
- Access to the fitness room and sauna
- Music entertainment and library access
- Selection of equipment for outdoor activities off ship

+ Upgrade your voyage with:

- + Daily breakfast, lunch, and dinner in award-winning fine dining restaurant Røst
- + Unlimited selected drinks in Røst during opening hours with an upgraded wine selection
- + Unlimited handcrafted cocktails in the bar during opening hours
- + Afternoon tea with sparkling wine
- + Hurtigruten clothing package including items suited to your voyage
- + Camera equipment and binoculars rental
- + Wide range of optional seasonal excursions and guided hikes
- + Expert-led cocktail masterclass and wine tasting

FOR GUESTS IN SUITES

For the absolute best in onboard comfort, cuisine, service, and beautifully appointed rooms, choose our Signature voyages suite experience.

Accommodation

- Choice of suite type
- Choice of suite location ^{FULL VOYAGES ONLY}
- Fast track, priority check-in
- Accommodation in a stylish, spacious suite with ensuite bathroom
- No charge on any items in your suite's minibar
- Daily minibar refill
- King-size beds
- Daily turndown service
- Hurtigruten clothing package including items suited to your voyage ^{FULL VOYAGES ONLY}

Food and drink

- Choice of dining times during the main restaurant's opening hours
- Daily breakfast, lunch, and dinner in the ship's main restaurant Flora
- Daily lunch and dinner in Brasserie Árran
- Daily breakfast, lunch, and dinner in award-winning fine dining restaurant Røst
- Exclusive dinner with the ship's officers
- Unlimited selected drinks in Flora, Brasserie Árran, and 1893 Bar during opening hours
- Unlimited selected drinks in Røst during opening hours
- Unlimited cocktails in the bar during opening hours
- Unlimited tea and coffee (selected types offered)
- Culinary demonstrations and food tastings
- Occasional afternoon tea with cakes and sparkling wine
- Local beer tasting

Life on board

- Complimentary Wi-Fi throughout the ship and in your suite
- Multi-lingual Expedition Team
- Access to the fitness room and sauna
- Daily themed lectures, photography guidance, arts and crafts sessions
- Music entertainment and library access
- Selection of equipment for outdoor activities off ship
- Visit to the bridge when in port - at the Captain's discretion
- Complimentary use of binoculars
- 2,500 NOK in onboard credit ^{FULL VOYAGES ONLY}

+ Upgrade your voyage with:

- + Camera equipment rental
- + Wide range of optional seasonal excursions and guided hikes
- + Expert-led cocktail masterclass and wine tasting

GET THE FULL UPGRADE PACKAGE

Enjoy the finest in onboard hospitality when you upscale your Signature voyage with our Upgrade Package.

Treat yourself to an upgrade and enjoy the best we have to offer for guests on our Signature voyages. With gourmet dining, all-inclusive beverages, and exclusive invites to meet with the ship's officers, there's no more stylish way to travel. The Upgrade Package is available to anyone who has booked an Inside, Outside, or Arctic Superior cabin.

A first-class welcome

After skipping the queue with your priority check-in, a special welcome gift of snacks from Norway's Coastal Kitchen and a bottle of Champagne on ice await you in your cabin-of-choice. What better way could there be to start your voyage! You'll also find a selection of branded clothing, including items suited to your voyage. And to make your experience as enjoyable as possible, we'll give you 2,500 NOK per cabin in onboard credit to spend as you wish, as well as free Wi-Fi.

Next-level dining

Begin each day with an excellent breakfast in our Røst fine dining restaurant. Later, after an indulgent afternoon tea, you'll have the added

option of taking lunch and dinner in the ship's à la carte Brasserie Árran at a time of your choosing. All-inclusive beverages are part of your upgrade, giving you a wide range of wines, cocktails, beers and premium drinks to sample on your voyage.

Onboard privileges

With priority status while on board, you'll feel like a VIP at sea. The Captain will give you an exclusive look behind the scenes up on the ship's bridge, a place very few get to experience. During your voyage there's a daily turn-down service for your cabin or suite, and when it's time to leave the ship there's no need to hurry, you can check out late and avoid any rush.

To upgrade your voyage, just speak to us when making your booking by phone.



© SHUTTERSTOCK / ESPEN MILLS / AGURT XANE CONCELLON

MS TROLLFJORD

Named after a small spectacular fjord in the Vesterålen archipelago in Arctic Norway, MS Trollfjord is the award-winning flagship of our Signature voyages.

In summer, it follows the Midnight Sun and sails to the top of the world on The Svalbard Line. During winter, it brings our guests on The North Cape Line to the northernmost point in Europe in search of the aurora.

For relaxing

- Complimentary Wi-Fi throughout the ship
- Double-storey viewing lounge on the top floors
- Large outdoor observation deck and walk-around deck
- Sauna with large windows on the upper floor
- Fitness room with large windows on the upper floor
- In-depth lectures with the Expedition Team
- Activity programme, including a photography workshop
- Library with a selection of books in various languages
- Onboard shop with essentials and souvenirs

Food and drink

- Main restaurant Flora for all three daily meals
- Rustic Sámi-inspired cuisine at Brasserie Árran
- Five-course Arctic fine dining restaurant Røst
- 1893 bar with extensive list of beers, wines, spirits, and cocktails

Cabins: 249 and 21 suites

Year of construction: 2002

Refurbished: 2023

Shipyard: Fosen Mek.

Verk., Norway

Gross tonnage: 16,140

Length: 135.75 metres

Beam: 21.5 metres

Service speed: 15 knots



MS Trollfjord



Expedition Suite



Røst Arctic fine dining

© ESPEN MILLS / HURTIGRUTEN; SALVATORE RIZZO / HURTIGRUTEN

| | CATEGORY | DECK | SIZE (m ²) | DESCRIPTION |
|-------------------|-------------------------|---------|------------------------|---|
| EXPEDITION SUITES | MX Owner's suite | 8 | 43-45 m ² | Two-room suite, king-size bed, bathtub, seating area, dining table, TV, kettle, minibar, private balcony. |
| | MG Grand suite | 7, 8 | 25-35 m ² | One-room suite, king-size bed, seating area, TV, kettle, minibar, some with bathtub, bay window or private balcony. |
| | M Suite | 7 | 23-24 m ² | One-room suite, king-size bed, TV, kettle, minibar and private balcony. |
| | Q Mini suite | 6, 7 | 16-24 m ² | One-room suite, king-size bed, seating area, TV, kettle, minibar. |
| ARCTIC SUPERIOR | QJ Outside cabin | 6, 7 | 16-17 m ² | With limited/no view, double bed, seating area, TV, kettle, minibar. |
| | YA Outside cabin | 6 | 16 m ² | Three single beds, one is an upper berth, table, TV, kettle, minibar. Adapted for guests with limited mobility. |
| | U Outside cabin | 4, 7, 8 | 10-14 m ² | Most with double bed. Some with twin beds, one of which converts into a sofa. Some cabins with table, kettle, minibar. |
| | P Outside cabin | 6 | 10-11 m ² | Double bed, kettle, minibar. |
| POLAR OUTSIDE | O Outside cabin | 4, 6 | 10-11 m ² | Two single beds, one of which converts into a sofa. Some with double bed. |
| | N Outside cabin | 4 | 10-11 m ² | Two single beds, one of which converts into a sofa or upper and lower berths. |
| | L Outside cabin | 4 | 10-11 m ² | Two single beds, one of which converts into a sofa, some with upper and lower berths. Some portholes have a limited view. |
| | J Outside cabin | 6, 7 | 11-12 m ² | Three single beds, one converts into a sofa and one is an upper berth. Windows with limited or no view. |
| POLAR INSIDE | K Inside cabin | 6, 7 | 9-11 m ² | Twin beds, one of which converts into a sofa or upper and lower berths. |
| | I Inside cabin | 4 | 9-11 m ² | Twin beds, one of which converts into a sofa or upper and lower berths. |

All information is subject to change.



Learn more about MS Trollfjord

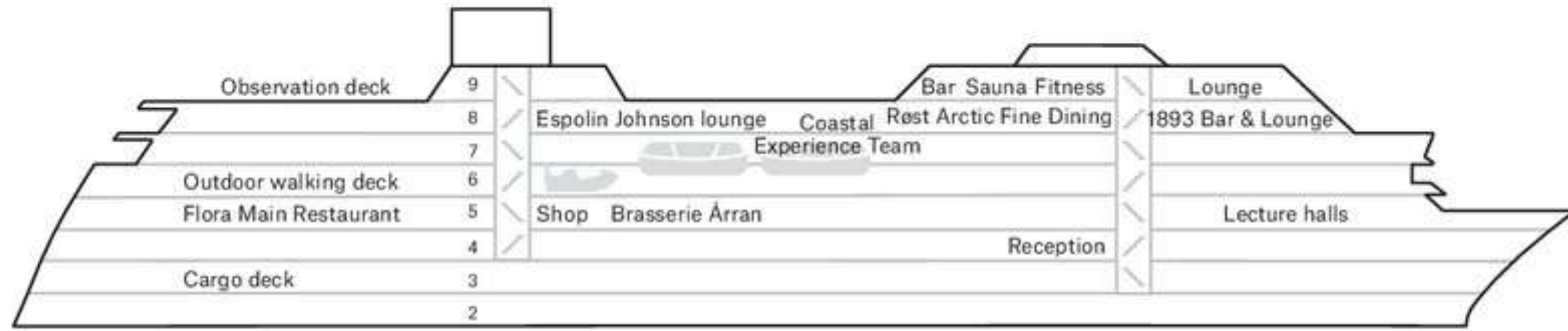

Deck

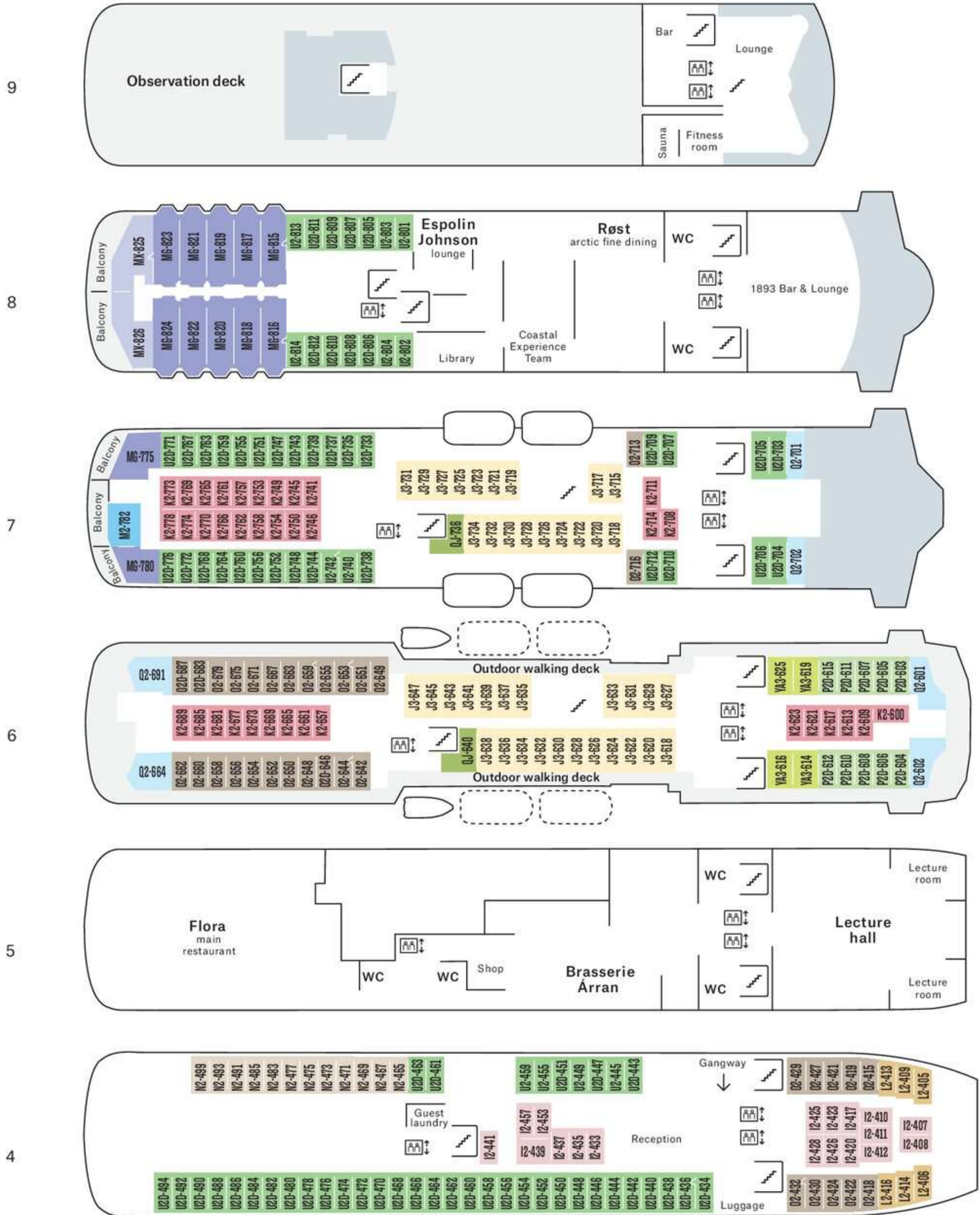

WHAT TO EXPECT

Original

VOYAGES



The original Coastal Express we founded over 130 years ago



See 34 diverse ports with ten minutes to four hours in each



Regional Norwegian ingredients sourced as we sail at 15 ports



Travel like a local with local Norwegians returning home

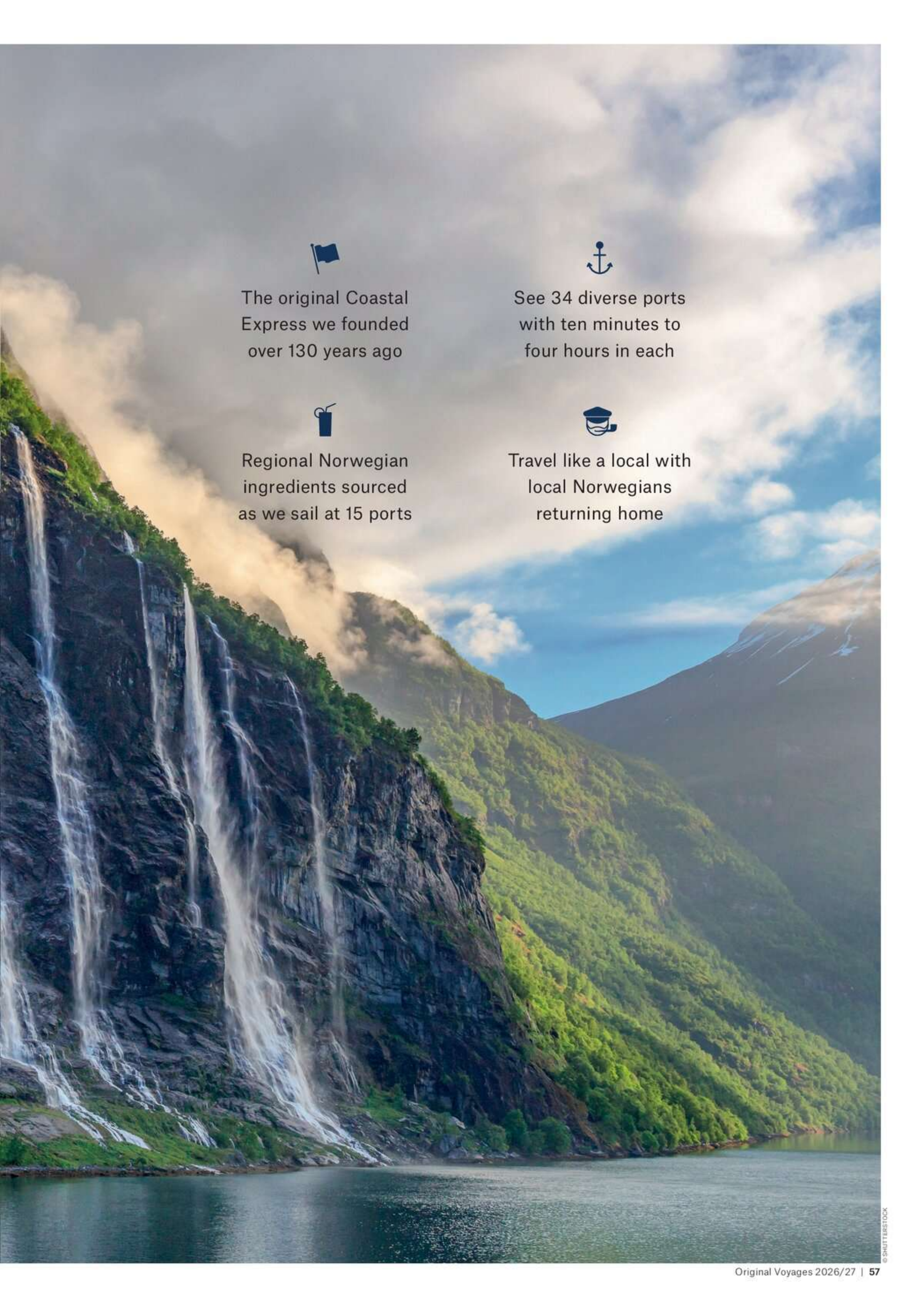

HEART AND SOUL OF NORWAY

Our Original voyages sail The Coastal Express along the postal route, the service our founder Captain Richard With began over 130 years ago. It is an intimate part of life on the coast and has been for generations.

The Original, since 1893

USA has Route 66. Japan has the bullet train. For Norway, we have Hurtigruten's The Coastal Express. We are the original Norwegian coastal voyage, loved by locals and the world.

'The World's Most Beautiful Voyage'

That's how Lonely Planet described The Coastal Express. It is 12 days, 34 ports big and small, and 2,500 nautical miles from southwestern Norway to the Arctic Norwegian border and back.

The charm of everyday Norway

Many Norwegians use our ships to return home on the coast.

For our guests, you'll see heart-warming scenes of people greeting and hugging one another at many of our ports.

Local ingredients, local flavours

We bring cargo to the coastal communities, including transporting cars. At 15 of the ports, we pick up food and drinks to serve you on board. It's as fresh and as local as it gets.

Watch the coast float by

Fall into the peaceful rhythm of life at sea, gazing at the coast from the lounge, gym, sauna, or outdoor hot tubs. To learn more about Norway, join the Expedition Team for a lecture.

"The World's Most Beautiful Voyage"

— LONELY PLANET





A JOURNEY OF FLAVOURS

Norway's coast is beautiful, raw, and bountiful. As we sail, we pick from its pantry. Its mountains are our herb garden. The fjords, our vegetable patch.

Torget

Meaning 'marketplace' in Norwegian, our main restaurant offers a variety for all three daily meals, which are buffets and set menus. Expect a selection of meat, fish, vegetarian, and vegan dishes to enjoy.

Kysten

Dine in style at 'The Coast', our à la carte option. You'll savour exquisite dishes crafted by our most skilled chefs, using the finest ingredients the Norwegian coast has to offer. We recommend the fresh and succulent king crab.

Brygga

The name of this bistro is the Norwegian word for 'wharf'. It serves traditional Nordic dishes, as well as salads, pizzas, and other crowd-pleasers, like

our signature fresh shrimp sandwich served with eggs and dill mayonnaise.

Multe

This onboard bakery serves cakes, waffles, pastries, and open sandwiches called *smørbrød*, along with smoothies, coffees, and a range of ice creams from Lofoten. The name of the bakery means 'cloudberry' in Norwegian.

Explorer Bar

The lounge's bar has hot drinks, fruit juices, various beers, wine, and a collection of Norwegian aquavit that would make any spirit lover jealous. Enjoy with a selection of snacks, including a Norwegian classic: dried fish.



Original

VOYAGES





Expedition Suite



Polar Outside Cabin



Lofoten Seaweed products



Arctic Superior Cabin



Arctic Superior Cabin



Polar Outside Cabin



Expedition Suite

HOME SUITE HOME

Feel cosy, warm, and calm on board our ships as you sail an Original voyage on The Coastal Express.

A feeling of *koselig*

We've applied a sense of Norwegian cosiness or *koselig* to the interiors of The Coastal Express fleet. Natural materials, comforting colours, soft lighting, and touches of Scandi décor add to a homely ambience.

The sounds of sleep

Cabins on the middle and lower decks may be closer to working areas of the ship such as the cargo bay, which operates around the clock on The Coastal Express. If you're a light sleeper sensitive to noise, it's better to pick a cabin or suite from Deck 5 and up.

Expedition Suites

Only located on the upper decks, these spacious, sublime rooms are the best The Coastal Express has to offer. All boast large windows with splendid views of the coast.

Arctic Superior

Enjoy an outside window with these bigger cabins which are usually situated on the upper or middle decks. Most have views of the passing scenery.

Polar Outside

Found on most decks, this category of cabin comes with a window or small porthole. Some cabins look out onto the mid-level walking deck.

Some Polar Outside cabins are accessible to guests who require adapted bathrooms and other mobility aids. Please note that standard cabins have raised door sills and may not be suitable for larger mobility aids.

Polar Inside

Similar in size to Polar Outside cabins, just without the window. Cabins may have single beds that can be combined into a double, or with one bed converting into a sofa.

Original
VOYAGES

VOYAGES

Original VOYAGES

THE COASTAL EXPRESS

The voyage that gave us our name, named 'The World's Most Beautiful Voyage' by Lonely Planet.

Sailing all year

12 days, 34 ports twice

Northbound only: 7 days, 34 ports

Southbound only: 6 days, 33 ports

Average of 6 ports per day

Port calls day and night

From 10 minutes to 4 hours in port

70+ optional seasonal excursions

THE COASTAL EXPRESS – SHORT VOYAGES

Pick from different sections of our famous route for the ideal long weekend or for tailor-made trips.

Sailing all year

5 days or less

Average of 6 ports per day

Port calls day and night

From 10 minutes to 4 hours in port





We always do our best to keep to our sailing schedule, but sometimes the weather and sea on the Norwegian coast has other plans. When the wind is too wild or the fog is too thick, we change the itinerary and adjust our services with safety in mind. This is part of the experience.

Original
VOYAGES

THE COASTAL EXPRESS

Our historic postal route as a lifeline to local communities sails the Norwegian coast day and night. Ports visited in the night on the northbound route are then seen by day southbound.

12
DAYS

Bergen - Kirkenes - Bergen

34 ports twice

Average of 6 ports per day

Between 10 minutes to 4 hours in port

Sailing all year



Snowmobiling

© 08 JAN BERTELSEN / HURTIGRUTEN

DAY 1: Bergen

Your journey begins in Bergen, 'The City of Seven Mountains', renowned for its colourful wooden wharves and bustling fish market.

DAY 2: Florø - Molde

Sail through idyllic fjords, past islets and skerries to the town of Ålesund and its Art Nouveau architecture.

DAY 3: Kristiansund - Rørvik

Visit Nidaros Cathedral, Norway's most famous church, and stroll through the charming Bakklandet district in the old Viking city of Trondheim.

DAY 4: Brønnøysund - Svolvær

Join us out on deck for a traditional ceremony to mark crossing the Arctic Circle. You're now in the realm of winter's Northern Lights and summer's Midnight Sun.

DAY 5: Stokmarknes - Skjervøy

Explore the city of Tromsø, the Arctic capital or enjoy an optional seasonal excursion such as skiing, kayaking, dog sledding, or cruising on a silent, electric boat.

DAY 6: Øksfjord - Berlevåg

Welcome to Troms & Finnmark, Sámi country, where the fjords make way for tundra, the bird cliffs of Honningsvåg and spectacular North Cape at the top of Europe.

🕒 northbound
🕒 southbound



Svolvær

© SHUTTERSTOCK

DAY 7: Båtsfjord – Kirkenes – Berlevåg

Kirkenes, a short distance from the border, marks your turning point. Ports that were passed at night northbound are visited during the day southbound.

DAY 8: Mehamn – Tromsø

Visit Hammerfest, home to a UNESCO-listed Meridian Column. Take in the views of the Lyngen Alps before arriving in Tromsø to enjoy an optional midnight concert.

DAY 9: Tromsø – Stamsund

See the unspoilt beauty of the fabled Vesterålen and Lofoten islands. Admire the dramatic scenery from out on deck or on an optional excursion.

DAY 10: Bodø – Rørvik

The stunning Helgeland Coast awaits, including the Seven Sisters mountain range and Torghatten Mountain, pierced by a natural tunnel.

DAY 11: Trondheim – Ålesund

Revisit the royal city of Trondheim, then sail to Kristiansund, Norway’s ‘Bacalao Capital’ before you reach Molde via the majestic Romsdal Alps.

DAY 12: Bergen

Don’t miss views of Nordfjord before you disembark in Bergen. Book a post-voyage extension to explore more of this historic city.

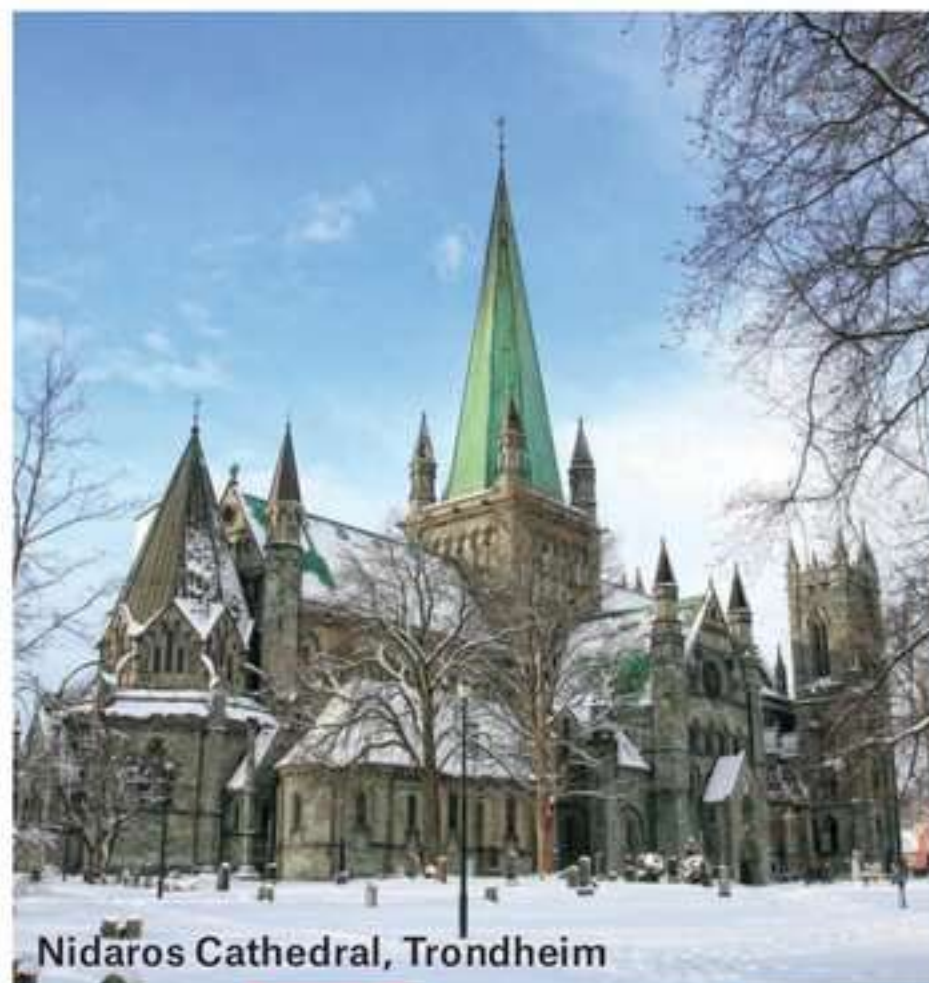

Nidaros Cathedral, Trondheim



Sea Eagle Safari



Sámi



Ålesund

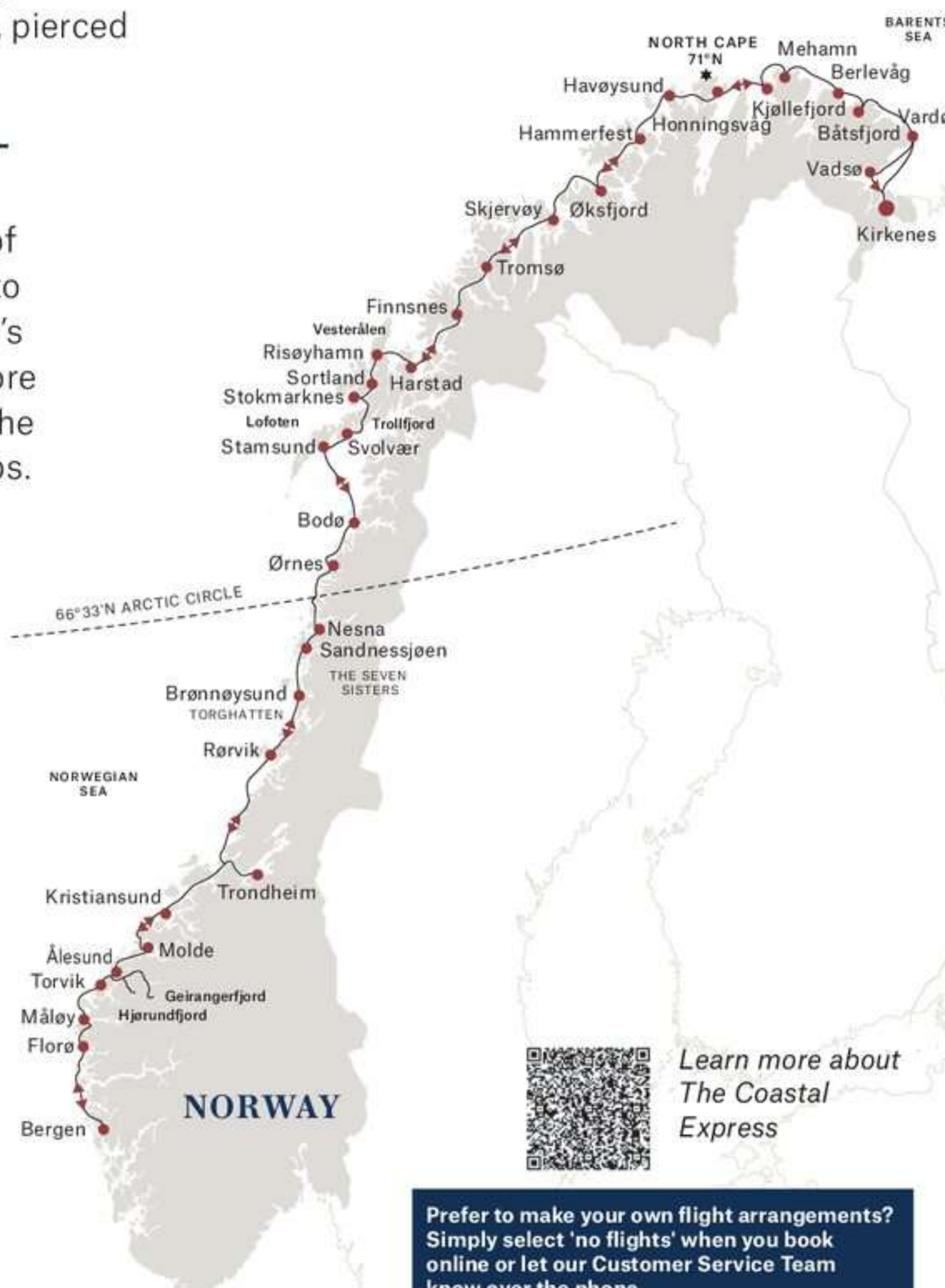

Learn more about The Coastal Express

Prefer to make your own flight arrangements? Simply select 'no flights' when you book online or let our Customer Service Team know over the phone.

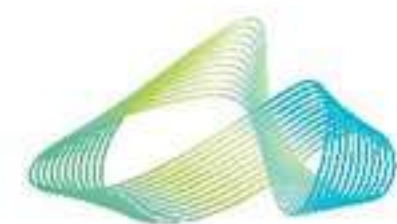

NORTHERN LIGHTS PROMISE

Free 6 or 7-day voyage if the aurora doesn't occur within sight of the ship on voyages of 11 days or more departing between 20 Sep & 31 Mar.*

INCLUDED

- Return economy flights from London (other UK airports are available for a supplement)
- Transfers to/from ship in Bergen
- 12-day full voyage on The Coastal Express
- The original Northern Lights Promise from Hurtigruten
- Daily breakfast, lunch, and dinner in the ship's main restaurant Torget
- Guiding by the onboard Expedition Team

| | |
|----------------------------|-----------------|
| Polar Inside Cabin from | £2,154pp |
| Polar Outside Cabin from | £2,359pp |
| Arctic Superior Cabin from | £3,024pp |
| Expedition Suite from | £4,540pp |

*Visit our website for terms and conditions.

Original VOYAGES

Bergen - Kirkenes

7 days, 34 ports

Average of 6 ports per day

Between 10 mins to 4 hours in port

Sailing all year

7

DAYS

THE COASTAL EXPRESS – NORTH

One week sailing north to the top of Norway, visiting the coast's biggest cities and towns along the way. Best for those that like history, culture, shopping, and sightseeing.

Starting from Bergen and disembarking in Kirkenes in the north, you'll be able to spend hours exploring the Art Nouveau inspired town of Ålesund; the royal city of Trondheim and its Nidaros Cathedral; Bodø just above the Arctic Circle, and Tromsø, capital of the Arctic.

It's not all about the towns and cities though. Sail in spring from March to May or autumn from September to October for the hidden gem of Urke in the Hjørundfjord or in summer between 1 June and 31 August to bask in the beauty of the UNESCO-listed Geirangerfjord.

Itinerary:

Day 1 | Bergen

Day 2 | Florø - Molde

Day 3 | Kristiansund - Rørvik

Day 4 | Brønnøysund - Svolvær

Day 5 | Stokmarknes - Skjervøy

Day 6 | Øksfjord - Berlevåg

Day 7 | Båtsfjord - Kirkenes



Learn more about
The Coastal
Express - North

INCLUDED

- Return economy flights from London (other UK airports are available for a supplement)
- Transfers to/from ship in Bergen and Kirkenes
- 7-day northbound half voyage on The Coastal Express
- Daily breakfast, lunch, and dinner in the ship's main restaurant Torget
- Guiding by the onboard Expedition Team

| | |
|----------------------------|-----------------|
| Polar Inside Cabin from | £1,893pp |
| Polar Outside Cabin from | £2,046pp |
| Arctic Superior Cabin from | £2,544pp |
| Expedition Suite from | £3,682pp |

Prefer to make your own flight arrangements? Simply select 'no flights' when you book online or let our Customer Service Team know over the phone.



Bergen



Friluftsliv!

Original VOYAGES

Kirkenes - Bergen

33 ports

Average of 6 ports per day

Between 10 mins to 4 hours in port

Sailing all year

6

DAYS

THE COASTAL EXPRESS – SOUTH

The ideal pick for nature lovers with less than a week to spare. You'll enjoy daytime sailings of Norway's most beautiful archipelagos and striking mountain ranges.



Trondheim



Seven Sisters, Helgeland Coast

Sail from the dramatic Arctic landscapes of northern Norway down past Lyngenfjord to Senja, one of Norway's most scenic islands. We'll then weave through the beautiful Vesterålen and Lofoten islands, with a possible detour into Trollfjord.

Further south, the ship takes in views of the Helgeland Coast. Legend has it that the Seven Sisters mountain range are seven troll princesses turned to stone. Likewise, the dramatic natural tunnel that pierces the

centre of Torghatten mountain is also the inspiration for some local lore.

Itinerary:

- Day 1 | Kirkenes
- Day 2 | Mehamn - Tromsø
- Day 3 | Tromsø - Stamsund
- Day 4 | Bodø - Rørvik
- Day 5 | Trondheim - Ålesund
- Day 6 | Ålesund - Bergen



Learn more about
The Coastal
Express - South

INCLUDED

- Return economy flights from London (other UK airports are available for a supplement)
- Transfers to/from ship in Kirkenes and Bergen
- 6-day southbound half voyage on The Coastal Express
- Daily breakfast, lunch, and dinner in the ship's main restaurant Torget
- Guiding by the onboard Expedition Team

| | |
|----------------------------|-----------------|
| Polar Inside Cabin from | £1,634pp |
| Polar Outside Cabin from | £1,744pp |
| Arctic Superior Cabin from | £2,067pp |
| Expedition Suite from | £2,922pp |

Prefer to make your own flight arrangements? Simply select 'no flights' when you book online or let our Customer Service Team know over the phone.

SHORT VOYAGES

You can also choose to do just a few days of The Coastal Express route. These are ideal for long weekend getaways or as an add-on to your other plans in Norway.



NORTHBOUND

West Fjords to the Arctic Capital

5 days | Bergen–Tromsø

West Fjords to Lofoten

4 days | Bergen–Svolvær

Lofoten to the Norwegian Border

4 days | Svolvær–Kirkenes

West Fjords to the Viking Capital

3 days | Bergen–Trondheim

Viking Capital to the Arctic Capital

3 days | Trondheim–Tromsø

Arctic Capital to the Norwegian Border

3 days | Tromsø–Kirkenes

SOUTHBOUND

Lofoten to the West Fjords

4 days | Svolvær–Bergen

Arctic Capital to the West Fjords

4 days | Tromsø–Bergen

Arctic Capital to the Viking Capital

3 days | Tromsø–Trondheim

Norwegian Border to Lofoten

3 days | Kirkenes–Svolvær

Norwegian Border to the Arctic Capital

2 days | Kirkenes–Tromsø

Viking Capital to the West Fjords

2 days | Trondheim–Bergen



Learn more about
our Short Voyages



Fishing village

Original
VOYAGES

WHAT'S INCLUDED

Sail on one of our Original voyages and enjoy our feel-at-home Hurtigruten hospitality.

© AGURTYANE CONCELLON

FOR GUESTS IN CABINS

Enjoy various included benefits when you choose from our selection of comfortable options: Polar Inside, Polar Outside, and Arctic Superior cabins.

Accommodation

- Choice of cabin type
- Choice of cabin location FULL VOYAGES ONLY
- Accommodation in a comfortable cabin with ensuite bathroom

Food and drink

- Daily breakfast, lunch, and dinner in the ship's main restaurant Torget
- Unlimited selection of tea and black filter coffee

Life on board

- Complimentary Wi-Fi throughout the ship and in your cabin
- Multi-lingual Expedition Team
- Daily themed lectures

+ Upgrade your voyage with:

- + Wine package (House, Superior, Premium)
- + Priority check-in
- + Welcome basket with sparkling wine
- + Traditional Norwegian wool sweater FULL VOYAGES ONLY
- + Choice of dining time
- + Dinner in fine dining restaurant Kysten
- + Wide range of optional seasonal excursions and guided hikes

FOR GUESTS IN SUITES

For the best in our Original voyages' onboard comfort, cuisine, service, and beautifully appointed rooms, choose our suite experience.

Accommodation

- Choice of suite type
- Choice of suite location FULL VOYAGES ONLY
- Fast track, priority check-in
- Accommodation in a stylish, spacious suite with ensuite bathroom
- Welcome basket with sparkling wine
- Traditional Norwegian wool sweater FULL VOYAGES ONLY

Food and drink

- Daily breakfast, lunch, and dinner in the ship's main restaurant Torget
- Unlimited selection of tea and black filter coffee

Life on board

- Complimentary Wi-Fi throughout the ship and in your cabin
- Multi-lingual Expedition Team
- Daily themed lectures

+ Upgrade your voyage with:

- + Wine package (House, Superior, Premium)
- + Choice of dining time
- + Dinner in fine dining restaurant Kysten
- + Wide range of optional seasonal excursions and guided hikes



 cameralla

SHARE THE PHOTO LOVE

Join the Cameralla photo sharing community and enjoy the absolute best photos from your voyage. Post your unique shots as the trip progresses and see what your fellow guests are sharing. Simply download the app and join your ship's exclusive Photo Club.

GET THE FULL UPGRADE PACKAGE

Enjoy the finest in onboard hospitality when you upscale your Original voyage with our Upgrade Package.



Treat yourself to an upgrade and enjoy the best we have to offer on the world's most beautiful voyage. With all-inclusive beverages, reserved window seating, gourmet dining, and exclusive invites to meet with the ship's officers, there's no more stylish way to experience Norway's coast. It doesn't matter which cabin category you've booked, our Upgrade Package is available to everyone.

A first-class welcome

After skipping the queue with your priority check-in, a special welcome gift of snacks from Norway's Coastal Kitchen and a bottle of sparkling wine on ice await you in your cabin-of-choice. What better way could there be to start your voyage! You'll also find a selection of branded clothing, including items suited to your voyage. And to make your experience as enjoyable as possible, we'll give you 2,500 NOK per cabin in onboard credit to spend as you wish, as well as free Wi-Fi.

Next-level dining

Begin each day with an indulgent breakfast at a reserved window seat from which to admire the passing scenery. Later, you can choose to eat dinner either in Torget or in the ship's à la carte restaurant, Kysten, at a time of your choosing. With all-inclusive beverages, as well as our coffee and tea package, you can enjoy a wide range of drinks at mealtimes and beyond.

Onboard privileges

With priority status while on board, you'll feel like a VIP at sea. The Captain will give you an exclusive look behind the scenes up on the ship's bridge, a place very few get to experience. During your voyage there's a daily turn-down service for your cabin or suite, and when it's time to leave in Bergen or Kirkenes there's no need to rush as you can check out late.

To upgrade any full or half voyage, just speak to us when making your booking by phone.

The Coastal Express

EXCURSIONS

With over 70 seasonal optional excursions to choose from, you'll get closer to Norway's dramatic landscapes, fascinating wildlife and captivating history.

Something for everyone

Choose from active excursions as diverse as kayaking, mountain hiking and horse riding. Cultural encounters will introduce you to the Sámi people, or bring you to a family-run dairy farm in Lofoten. For those who love architecture and history, city tours of Tromsø or Ålesund will engage and delight. With so many excursions to pick from, there's truly something for everyone.

Love of the great outdoors

Norway's famed *friluftsliv* is at the heart of many of our excursions. Cycling and RIB boat safaris take advantage of the summer and autumn weather, while dogsledding or skiing let you enjoy the spring and winter wonderland. Love hiking? So do the Expedition Team, who'll show you some of Norway's most beautiful places.

Some of our excursions

- Midnight candlelit church concert in Tromsø
- Trollfjord wildlife safari in search of Sea Eagles
- Visit the dramatic North Cape – Europe's most northerly point
- Hop on a snowmobile and ride through a winter wonderland
- Feel the wind on your face on a winter dogsledding tour
- Learn about the Sámi way of life as they welcome us to their camp



RIB Adventure in Lofoten



Mountain Hike in Hammerfest



King Crab Adventure



The excursions we offer sometimes change. For an up-to-date list, more information, and prices, please visit our website.

THE RIGHT FIT

Whether you're into hiking up Torghatten Mountain or you'd rather go on a scenic bus tour in Lofoten, we want everyone to enjoy our optional excursions. That's why we make it easy to choose what's right for you.

Level 1 Easy

Suitable for most

Level 2 Moderate

Some mobility needed

Level 3 Active

Good mobility needed

Level 4 Challenging

Good mobility and fitness needed



Snowmobile Trip in the Polar Night



Original
VOYAGES

The Coastal Express

EXPLORE MORE NORWAY

Get the most out of your holiday by adding a day or more before or after your voyage with us.

NORWAY IN A NUTSHELL

Take the scenic train from either Bergen or Oslo to the mountain station at Myrdal. There, you'll transfer to the Flåm Mountain Railway, one of the most beautiful train journeys in the world, including a photo-stop at Kjosfossen waterfall.

Once in the fjord-side village of Flåm, drop into the Flåm Railway Museum before an electric boat brings you out onto Aurlandsfjord for a two-

hour cruise to UNESCO-listed Nærøfjord. The mountains that flank the fjords range between 1,400 and 1,600 metres high, creating a truly spectacular landscape.

Disembark the boat at Gudvangen where a bus drive you through Nærøydalen valley. The driver will take the mountain road that leads to the village of Voss where you'll catch the train back to Bergen or Oslo.

Availability: All year
Start point: Bergen or Oslo
End point: Bergen or Oslo

One-day tour

Duration: 9-14 hours

Two-day tour

One hotel night in Flåm or in Voss

Three-day tour

One hotel night in Flåm and one hotel night in Voss



Sognefjord



Flåm Mountain Railway

SOGNEFJORD IN A NUTSHELL

Similar to the Norway in a Nutshell programme, this tour also includes a train from either Bergen or Oslo to Myrdal, and then the Flåm Mountain Railway with a photo-stop at Kjosfossen waterfall.

You'll visit the Railway Museum in Flåm before joining a cruise that starts from Aurlandsfjord, an arm of Sognefjord, Norway's longest fjord. The cruise then takes you through most of Sognefjord, giving you front-row seats to the so-called 'King of Fjords' and the surrounding mountains which tower some 2,000 metres tall.

Exiting Sognefjord, the boat will travel out into open sea, and hug the coast south to Bergen. Those headed to Norway's capital can then take the train from Bergen to Oslo.

Availability: 1 June – 30 Sept
Start point: Bergen or Oslo
End point: Bergen or Oslo

One-day tour

Duration: 10-14 hours

Two-day tour

One hotel night in Balestrand

SNOWHOTEL AND GAMME CABINS, KIRKENES

Open year-round and made from several tonnes of snow and ice, the large, extended igloo contains illuminated sculptures and wall carvings throughout its interiors, including in the Snow Bar and Snow Suites.

Reindeers graze behind the hotel and the nearby Dogyard is home to 180 friendly Alaskan husky dogs and their loveable puppies. The hotel offers a range

of seasonal activities, including fishing, dog sledding, mountain hiking, and snowmobiling.

Warm up with a session in the sauna before enjoying a delicious three-course dinner, made from locally sourced ingredients. Choose to spend the night in a unique Snow Suite, complete with thermal sleeping bag, or in a wooden, ensuite Gamme Cabin with their signature large windows.

Availability: All year
Start point: Kirkenes
End point: Kirkenes

Two-day stay (one night) in a Snow Suite

Two-day stay (one night) in a Gamme Cabin



Learn more about extending your holiday

© SHUTTERSTOCK. © TOM L. NILSEN / KIRKENES SNOWHOTEL



Gamme Cabins



All Pre- and Post-Programmes involve minimal physical activity and are mostly vehicle operated. The Sognefjord in a Nutshell programme is not suitable for guests with limited mobility.



Original
VOYAGES

The Coastal Express

MEET OUR FLEET

MS RICHARD WITH

Proudly bearing the name of the famous Captain who founded Hurtigruten.

- 199 cabins and 19 suites
- Nordic style décor, refurbished in 2018
- Expedition Team
- Torget restaurant, Kysten fine dining, Brygga bistro, Multe bakery, and Explorer bar
- Sauna and panoramic fitness room
- Sun deck and two outdoor hot tubs
- Shop

MS KONG HARALD

In honour of His Majesty of Norway, the reigning monarch King Harald.

- 221 cabins and 2 suites
- Nordic style décor, refurbished in 2016
- Expedition Team
- Torget restaurant, Kysten fine dining, Brygga bistro, Multe bakery, and Explorer bar
- Sauna and panoramic fitness room
- Sun deck and two outdoor hot tubs
- Shop

MS NORDNORGE

Named after northern Norway, a region which lies above the Arctic Circle.

- 211 cabins and 12 suites
- Nordic style décor, refurbished in 2016
- Expedition Team
- Torget restaurant, Kysten fine dining, Brygga bistro, Multe bakery, and Explorer bar
- Sauna and panoramic fitness room
- Sun deck and two outdoor hot tubs
- Shop



MS NORDKAPP

The name means 'North Cape', the northernmost point on mainland Europe.

- 214 cabins and 10 suites
- Nordic style décor, refurbished in 2016
- Expedition Team
- Torget restaurant, Kysten fine dining, Brygga bistro, Multe bakery, and Explorer bar
- Sauna and panoramic fitness room
- Sun deck and two outdoor hot tubs
- Shop

MS POLARLYS

Translates to 'Polar Lights', a reference to the aurora which appears in polar regions.

- 218 cabins and 6 suites
- Nordic style décor, refurbished in 2016
- Expedition Team

- Torget restaurant, Kysten fine dining, Brygga bistro, Multe bakery, and Explorer bar
- Sauna and panoramic fitness room
- Sun deck and two outdoor hot tubs
- Shop

MS NORDLYS

Norwegian for the 'Northern Lights', another name for the aurora borealis.

- 200 cabins and 19 suites
- Nordic style décor, refurbished in 2019
- Expedition Team
- Torget restaurant, Kysten fine dining, Brygga bistro, Multe bakery, and Explorer bar
- Sauna and panoramic fitness room
- Sun deck and two outdoor hot tubs
- Shop

MS MIDNATSOL

Named after summer's 'Midnight Sun': 24-hour daylight in Arctic Norway.

- 251 cabins and 21 suites
- Nordic style décor, refurbished in 2019
- Expedition Team
- Torget restaurant, Kysten fine dining, Brygga bistro, Multe bakery, and Explorer bar
- Sauna and panoramic fitness room
- Sun deck and two outdoor hot tubs
- Shop

MS NORDNORGE

MS Nordnorge is named after northern Norway which consists of the two northernmost counties Nordland and Troms & Finnmark.

The ship is particularly famous for Norwegians who often recognise it from a TV show in 2011 when its voyage from Bergen to Kirkenes was broadcast live for 134 hours, non-stop.

For relaxing

- Viewing lounge on the top floor
- Large outdoor observation deck and walk-around deck
- Sauna and two outdoor hot tubs
- Fitness room with large windows on the upper floor
- Lectures with the Expedition Team
- Onboard shop with essentials and souvenirs

Food and drink

- Main restaurant Torget for all three daily meals
- Comfort food with a Nordic twist in Brygga bistro
- À la carte restaurant Kysten for elegant fine dining
- Pastries, cakes, and ice cream in Multe bakery
- Explorer bar offering a variety of Norwegian drinks



MS Nordnorge



Main restaurant Torget



Polar Outside

Cabins: 211 and 12 suites
Year of construction: 1997
Refurbished: 2018 & 2022
Shipyard: Kværner Kleven, Norway

Gross tonnage: 11,384
Length: 123.3 metres
Beam: 19.5 metres
Service speed: 15 knots

| | CATEGORY | | DECK | SIZE (m ²) | DESCRIPTION |
|-------------------|------------------|--|---------|------------------------|---|
| EXPEDITION SUITES | M Suite | | 5 | 26-38 m ² | One or two-room suite, TV, hairdryer, kettle. |
| | Q Mini suite | | 5, 6 | 17-23 m ² | One-room suite, seating area, TV, hairdryer, kettle. |
| ARCTIC SUPERIOR | QJ Outside cabin | | 6 | 17-22 m ² | With limited/no view, double beds, seating area, TV, hairdryer, kettle. |
| | U Outside cabin | | 6 | 10-12 m ² | Double bed, some with table, TV, hairdryer, kettle. |
| | P Outside cabin | | 5 | 10-12 m ² | Double bed, TV, hairdryer, kettle. |
| POLAR OUTSIDE | O Outside cabin | | 3, 5, 6 | 10-12 m ² | Double bed, some with twin or triple beds, sofa or chair, TV, hairdryer. Some with limited view. |
| | N Outside cabin | | 3 | 8-12 m ² | Double bed, some with twin or triple beds, chair, TV, hairdryer. |
| | SD Outside cabin | | 3 | 17 m ² | Cabin and one bed is adapted for guests with disabilities, one regular bed, TV, and hairdryer. |
| | L Outside cabin | | 2, 3 | 8-12 m ² | Double bed or twin beds, chair, TV, hairdryer. Some cabins have portholes with limited or no view. |
| POLAR INSIDE | J Outside cabin | | 5, 6 | 8-11 m ² | With limited/no view, two-berth cabins with double bed, three-berth cabins with separate beds (one upper bed), TV, hairdryer. |
| | K Inside cabin | | 5, 6 | 8-9 m ² | Separate beds, one bed can be turned into a sofa, TV, hairdryer. |
| | I Inside cabin | | 3 | 8-11 m ² | Separate beds, a chair, TV, hairdryer. |

Cabin category N and O – Please note that some outside cabins on upper decks can have obstructed views due to lifeboats.
 Cabin category P – Please note that these cabins can have obstructed views due to walking decks.
 All information is subject to change.



Learn more about MS Nordnorge

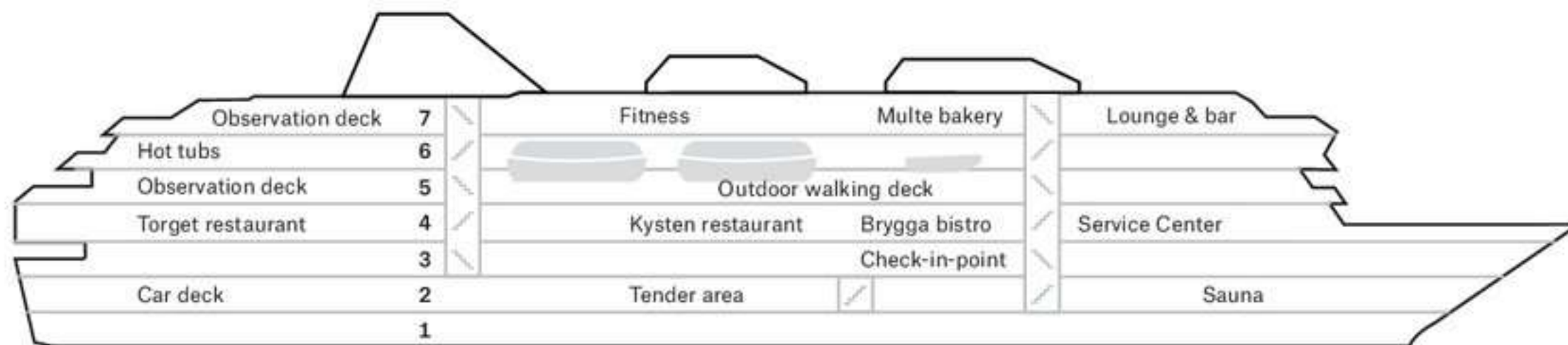

Deck

7

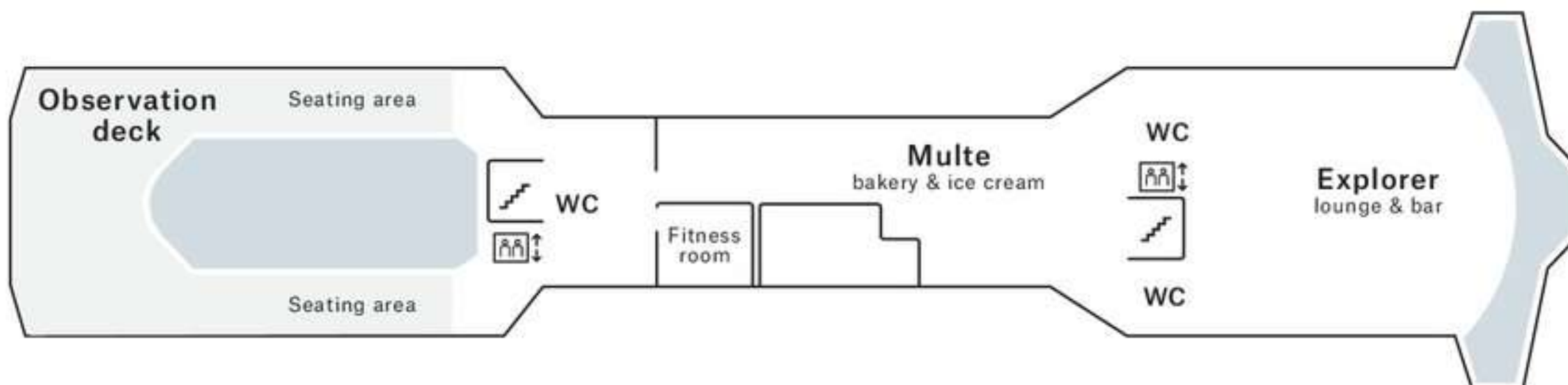

6

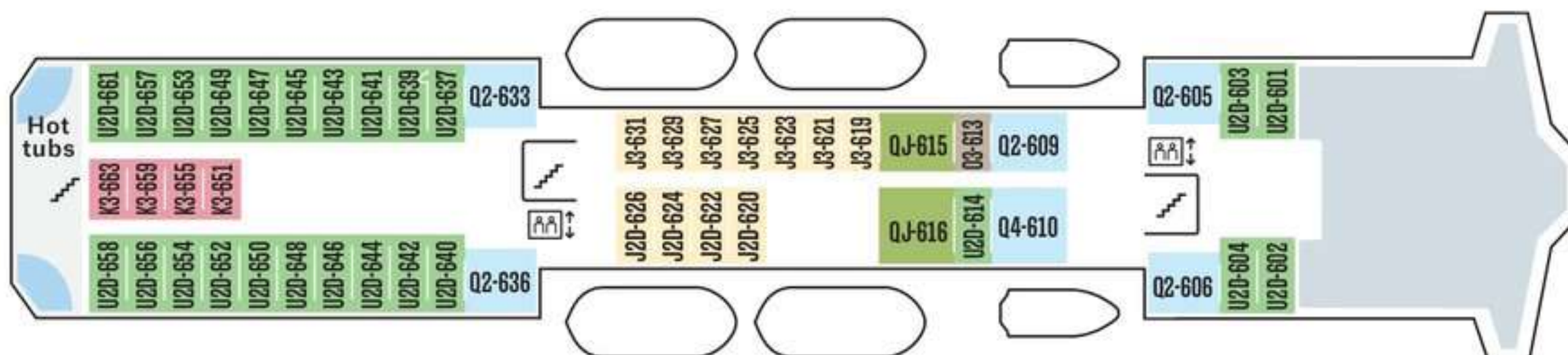

5

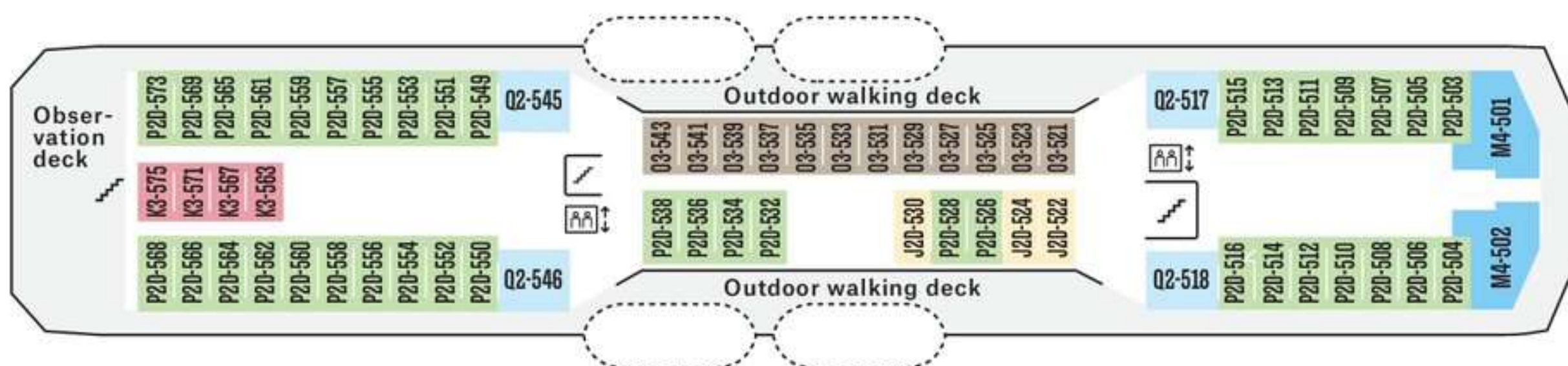

4

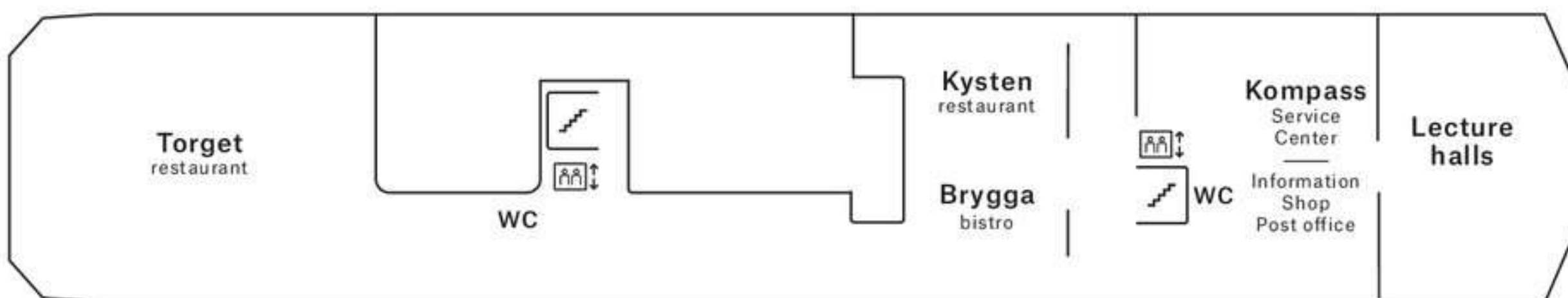

3

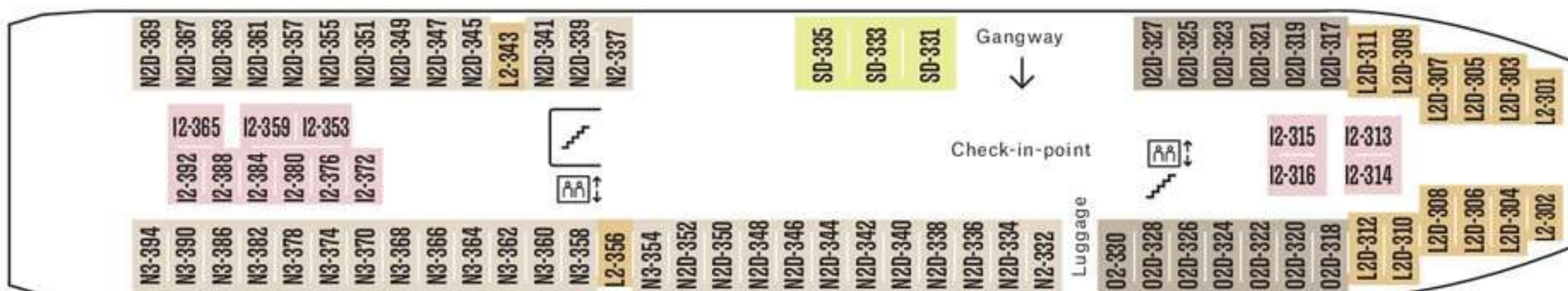

2

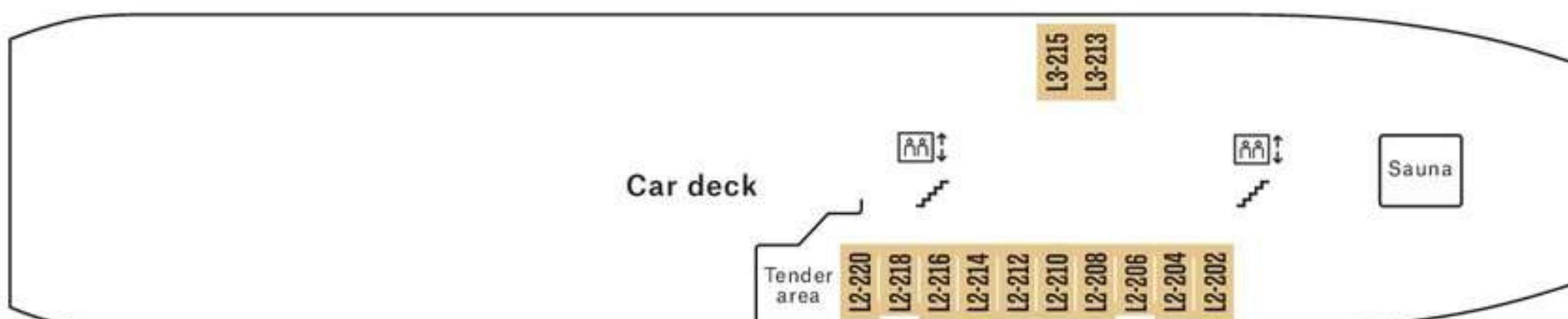

MS NORDKAPP

The ship is named after the iconic North Cape, the northernmost point on mainland Europe, accessible via the port of Honningsvåg, which we stop at.

Christened by Queen Sonja of Norway, MS Nordkapp briefly embarked on our expeditions to the Baltic Sea, Chile, and even Antarctica, before returning to the coastal route full time since 2007.

For relaxing

- Viewing lounge on the top floor
- Large outdoor observation deck and walk-around deck
- Sauna and two outdoor hot tubs
- Fitness room with large windows on the upper floor
- Lectures with the Expedition Team
- Onboard shop with essentials and souvenirs

Food and drink

- Main restaurant Torget for all three daily meals
- Comfort food with a Nordic twist in Brygga bistro
- À la carte restaurant Kysten for elegant fine dining
- Pastries, cakes, and ice cream in Multe bakery
- Explorer bar offering a variety of Norwegian drinks

Cabins: 214 and 10 suites

Year of construction: 1996

Refurbished: 2018 & 2022

Shipyard: Kværner
Kleven, Norway

Gross tonnage: 11,386

Length: 123.3 metres

Beam: 19.5 metres

Service speed: 15 knots



MS Nordkapp



Polar Outside



Multe Bakery & Ice cream

| | CATEGORY | | DECK | SIZE (m ²) | DESCRIPTION |
|-------------------|----------|---------------|---------|------------------------|---|
| EXPEDITION SUITES | M | Suite | 5 | 26-38 m ² | One or two-room suite, TV, hairdryer, kettle. |
| | Q | Mini suite | 5, 6 | 17-23 m ² | One-room suite, seating area, TV, hairdryer, kettle. |
| ARCTIC SUPERIOR | QJ | Outside cabin | 6 | 17-22 m ² | With limited/no view, double beds, seating area, TV, hairdryer, kettle. |
| | U | Outside cabin | 6 | 10-12 m ² | Double bed, some with table, TV, hairdryer, kettle. |
| | P | Outside cabin | 5 | 10-12 m ² | Double bed, TV, hairdryer, kettle. |
| POLAR OUTSIDE | O | Outside cabin | 3, 5, 6 | 10-12 m ² | Double bed, some with twin or triple beds, sofa or chair, TV, hairdryer. Some with limited view. |
| | N | Outside cabin | 3 | 8-12 m ² | Double bed, some with twin or triple beds, chair, TV, hairdryer. |
| | SD | Outside cabin | 3 | 17 m ² | Cabin and one bed is adapted for guests with disabilities, one regular bed, TV, and hairdryer. |
| | L | Outside cabin | 2, 3 | 8-12 m ² | Double bed or twin beds, chair, TV, hairdryer. Some cabins have portholes with limited or no view. |
| POLAR INSIDE | J | Outside cabin | 5, 6 | 8-11 m ² | With limited/no view, two-berth cabins with double bed, three-berth cabins with separate beds (one upper bed), TV, hairdryer. |
| | K | Inside cabin | 5, 6 | 8-9 m ² | Separate beds, one bed can be turned into a sofa, TV, hairdryer. |
| | I | Inside cabin | 3 | 8-11 m ² | Separate beds, a chair, TV, hairdryer. |

Cabin category N and O – Please note that some outside cabins on upper decks can have obstructed views due to lifeboats.
Cabin category P – Please note that these cabins can have obstructed views due to walking decks.
All information is subject to change.



Learn more about
MS Nordkapp

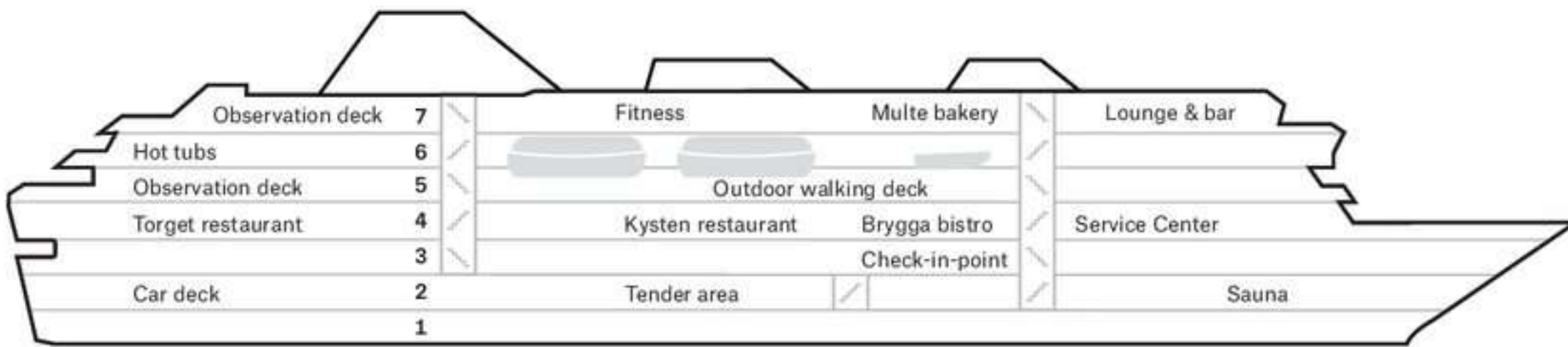

Deck

7

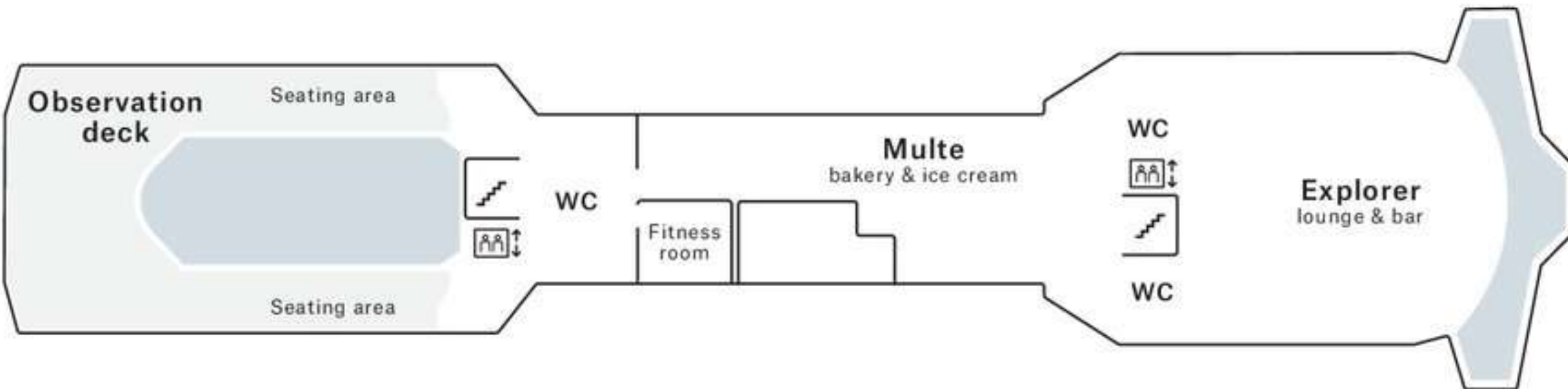

6

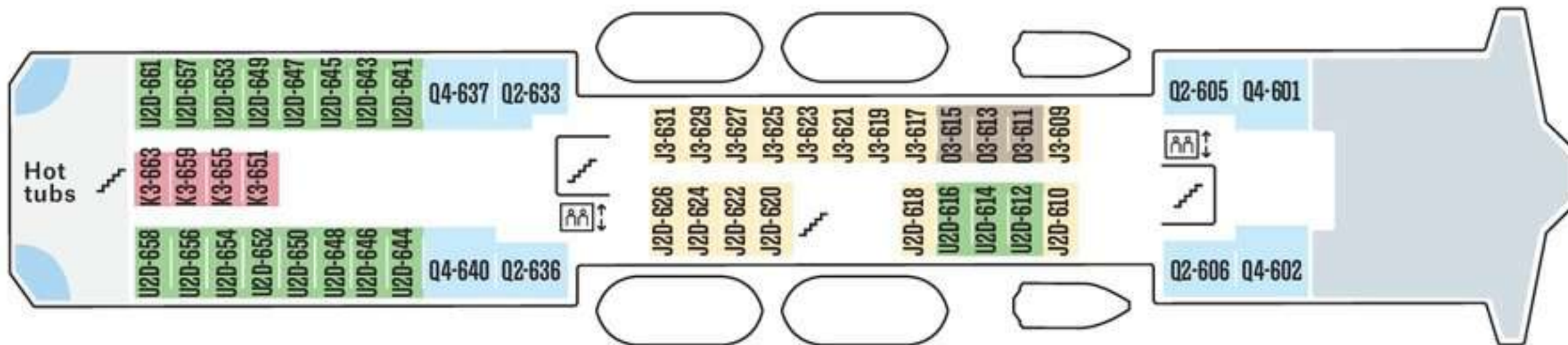

5

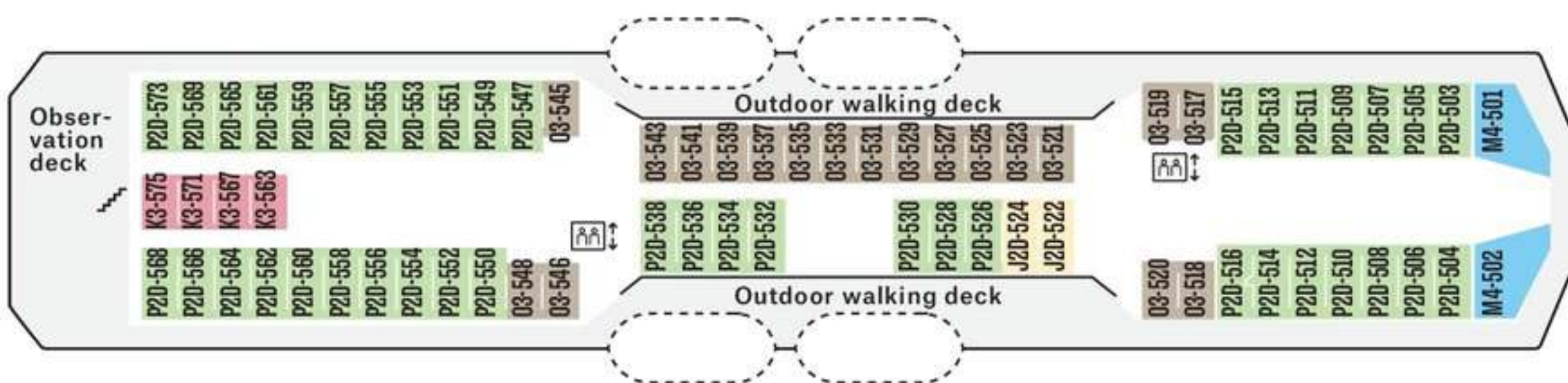

4

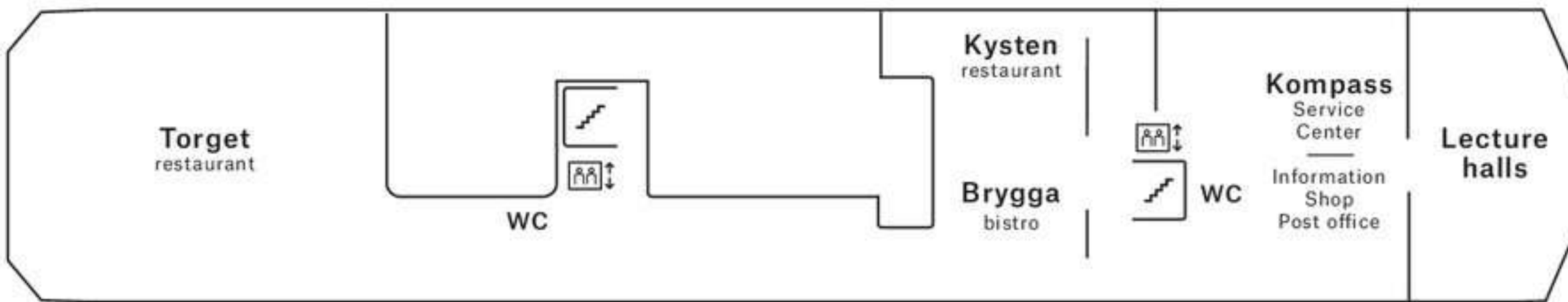

3

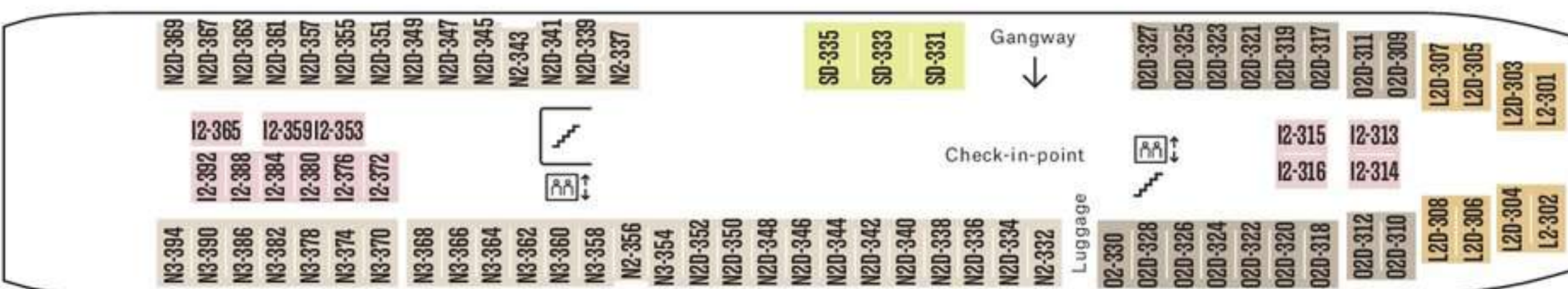

2

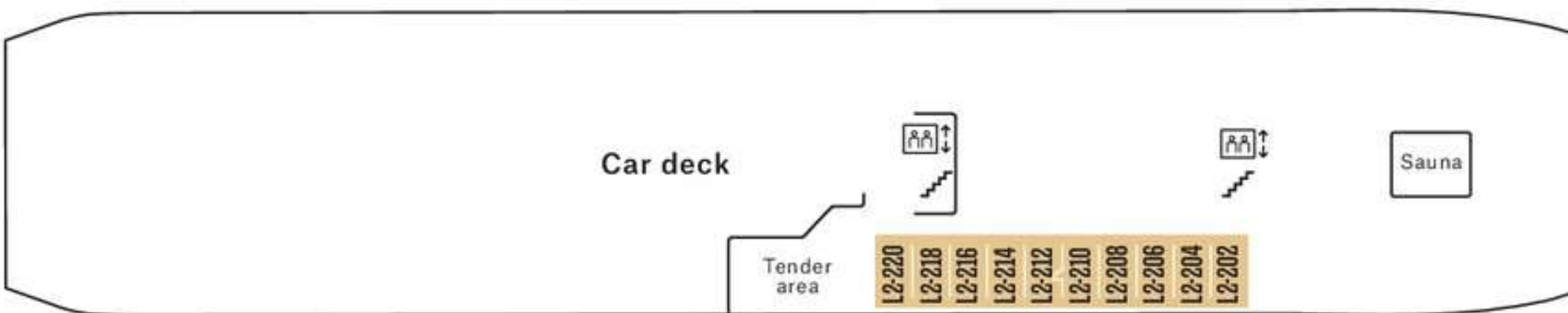

MS POLARLYS

The vessel's name means 'Polar Lights' in Norwegian, which is another word for the Northern Lights. Built in 1996, MS Polarlys had the honour of being christened by Queen Sonja of Norway.

MS Polarlys was remodelled in 2016 to include a modern, Arctic-inspired interior, and the cabins on deck 2 and 3 were upgraded in 2023.

For relaxing

- Viewing lounge on the top floor
- Large outdoor observation deck and walk-around deck
- Sauna and two outdoor hot tubs
- Fitness room with large windows on the upper floor
- Lectures with the Expedition Team
- Onboard shop with essentials and souvenirs

Food and drink

- Main restaurant Torget for all three daily meals
- Comfort food with a Nordic twist in Brygga bistro
- À la carte restaurant Kysten for elegant fine dining
- Pastries, cakes, and ice cream in Multe bakery
- Explorer bar offering a variety of Norwegian drinks

Cabins: 207 and 6 suites

Gross tonnage: 11,341

Year of construction: 1996

Length: 123 metres

Refurbished: 2016 & 2023

Beam: 19.5 metres

Shipyard: Ulstein Mek.

Service speed: 15 knots

Verk., Norway



MS Polarlys



Polar Outside



Explorer Lounge and Bar

| | CATEGORY | | DECK | SIZE (m ²) | DESCRIPTION |
|-------------------|----------|---------------|---------|------------------------|---|
| EXPEDITION SUITES | M | Suite | 6 | 28-30 m ² | One or two-room suite, double bed, seating area, TV, minibar, hairdryer, kettle, Wi-Fi. |
| | Q | Mini suite | 5, 6 | 16-19 m ² | One-room suite, double bed, sofa or chair, TV, minibar, hairdryer, kettle, Wi-Fi. |
| ARCTIC SUPERIOR | U | Outside cabin | 6 | 10-12 m ² | Double bed, chair, TV, hairdryer, kettle. |
| | P | Outside cabin | 5 | 10-13 m ² | Double bed, chair, TV, hairdryer, kettle. One cabin has limited view with no chair and kettle. |
| POLAR OUTSIDE | O | Outside cabin | 3, 5, 6 | 8-11 m ² | Double bed, some with separate or bunk beds, one bed can be turned into a sofa, chair, TV, hair dryer. |
| | N | Outside cabin | 3 | 10-12 m ² | Double bed, some with separate or bunk beds, one bed can be turned into a sofa, chair, TV, hair dryer. |
| | SD | Outside cabin | 3 | 17 m ² | Single beds, chair, TV, hairdryer. Cabin is adapted for guests with limited mobility. |
| | L | Outside cabin | 2, 3 | 8-12 m ² | Double bed, some with separate or bunk beds, one bed can be turned into a sofa, chair, TV, hair dryer. The cabins have portholes. |
| POLAR INSIDE | J | Outside cabin | 5, 6 | 8-12 m ² | Double bed, some with separate or bunk beds, one bed can be turned into a sofa, TV, hair dryer. With limited view. |
| | K | Inside cabin | 5, 6 | 8-9 m ² | Separate or bunk beds, one bed can be turned into a sofa, TV, hairdryer. |
| | I | Inside cabin | 3 | 8-11 m ² | Separate beds, one bed can be turned into a sofa, chair, TV, hairdryer. |

Cabin category N and O - Please note that some cabins on upper decks can have obstructed views due to lifeboats.
Cabin category P - Please note that the cabins can have obstructed views due to walking decks.
All information is subject to change.



Learn more about MS Polarlys

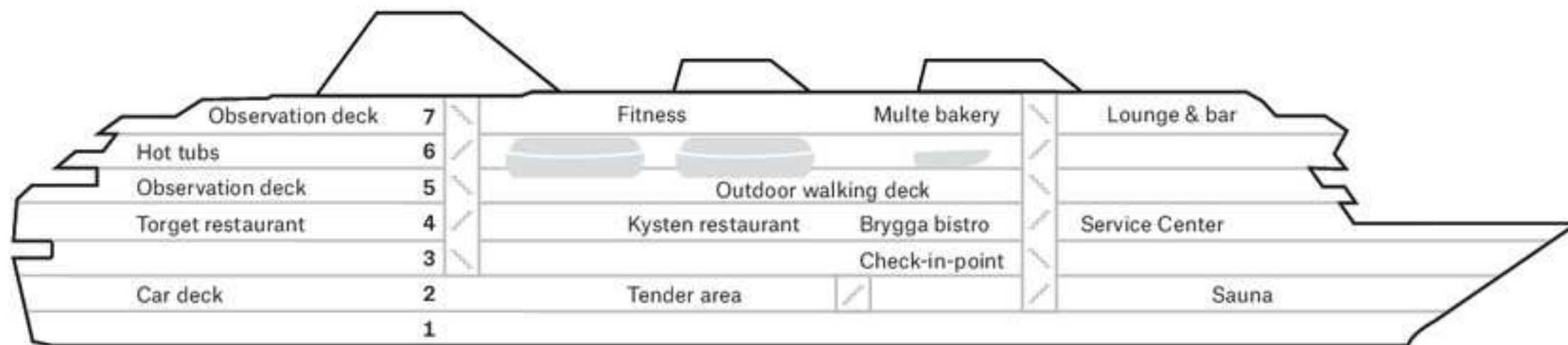

Deck

7

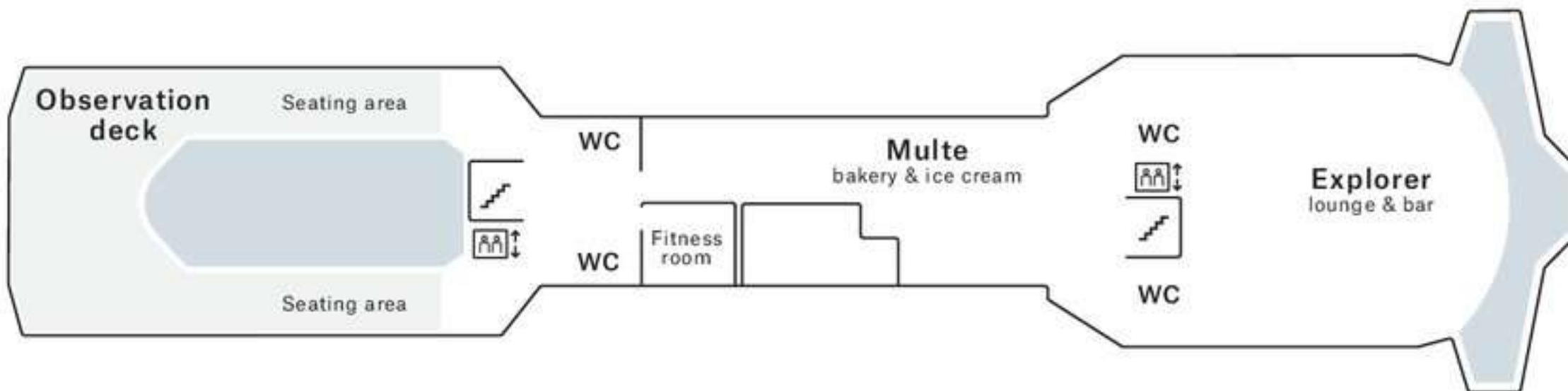

6

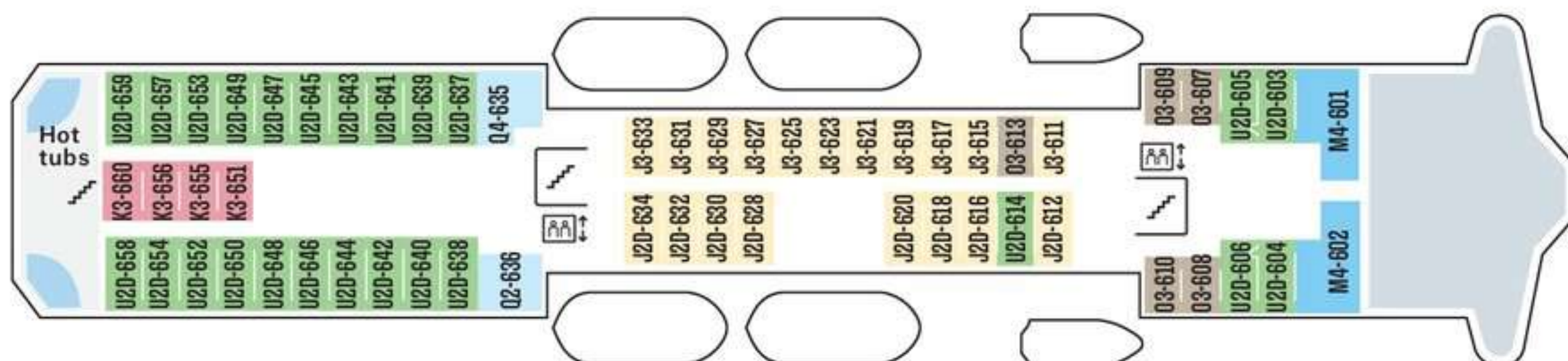

5

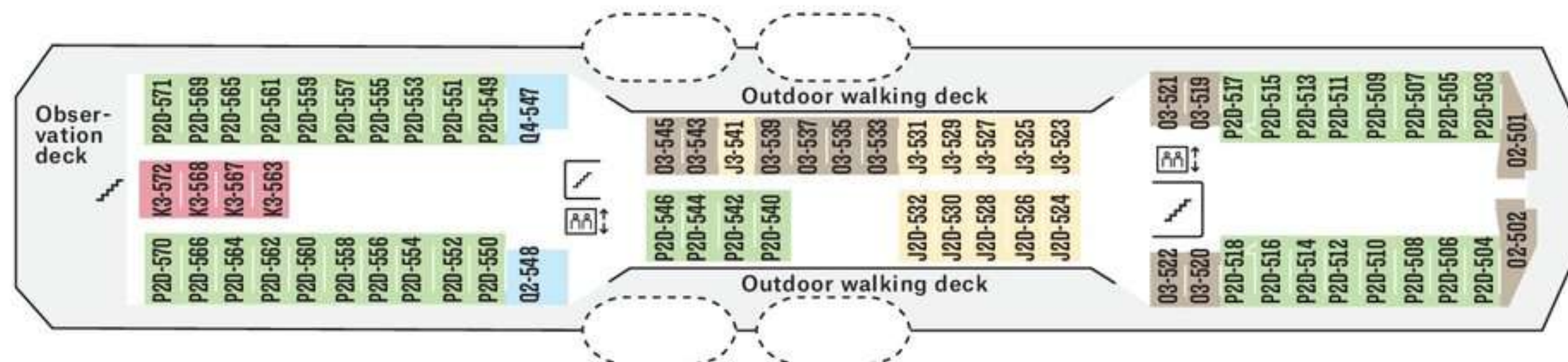

4

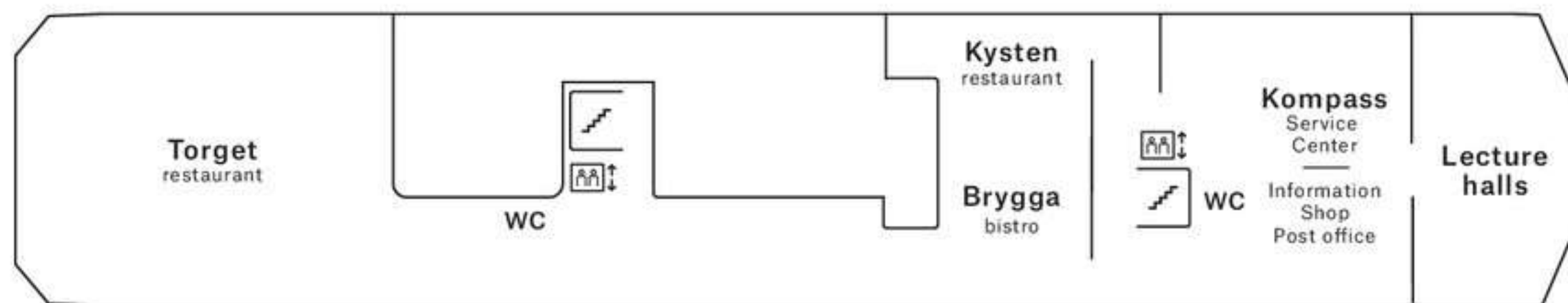

3

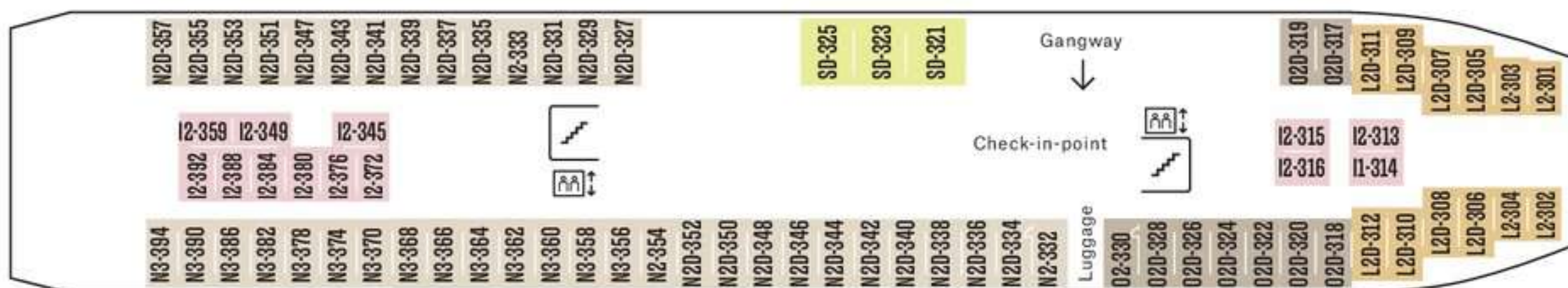

2

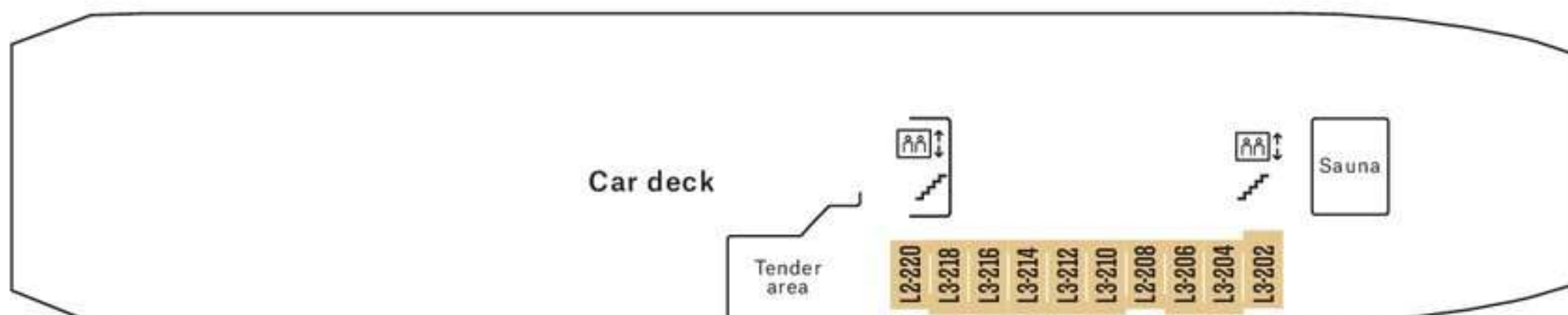

MS NORDLYS

MS Nordlys is named after the Northern Lights. Her interior design is similarly inspired by the aurora, with swirling patterns and design motifs reflecting nature's artwork.

And with a hybrid electric propulsion system to be installed in April 2025, she will sail silently beneath the breathtaking skies.

For relaxing

- Viewing lounge on the top floor
- Large outdoor observation deck and walk-around deck
- Sauna and two outdoor hot tubs
- Fitness room with large windows on the upper floor
- Lectures with the Expedition Team
- Onboard shop with essentials and souvenirs

Food and drink

- Main restaurant Torget for all three daily meals
- Comfort food with a Nordic twist in Brygga bistro
- À la carte restaurant Kysten for elegant fine dining
- Pastries, cakes, and ice cream in Multe bakery
- Explorer bar offering a variety of Norwegian drinks

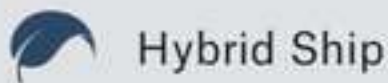

Hybrid Ship

Cabins: 180 and 20 suites **Gross tonnage:** 11,204
Year of construction: 1994 **Length:** 121.8 metres
Refurbished: 2019 **Beam:** 19.2 metres
Shipyard: Volkswerft, **Service speed:** 15 knots
 Germany



MS Nordlys



Polar Outside



Multe Bakery & ice cream

| | CATEGORY | DECK | SIZE (m ²) | DESCRIPTION |
|-------------------|------------------|------|------------------------|---|
| EXPEDITION SUITES | MG Grand suite | 6 | 15-20 m ² | Double bed, one sofa bed, seating area, TV, safe, minibar, bay window with full view. |
| | M Suite | 5 | 25-26 m ² | One or two-room suite, TV, kettle. |
| | Q Mini suite | 5, 6 | 17-23 m ² | One-room suite, seating area, TV, kettle. |
| ARCTIC SUPERIOR | U Outside cabin | 6 | 10-12 m ² | Double bed, some with table, TV, kettle. |
| | P Outside cabin | 5 | 11-12 m ² | Double bed, TV, kettle. |
| | O Outside cabin | 3, 6 | 8-12 m ² | Separate beds, one bed can be turned into a sofa. |
| | N Outside cabin | 3, 5 | 8-12 m ² | Separate beds, one bed can be turned into a sofa. |
| POLAR OUTSIDE | SD Outside cabin | 3 | 17 m ² | Separate beds, one bed can be turned into a sofa. Adapted for guests with limited mobility. |
| | L Outside cabin | 2, 3 | 8-12 m ² | With portholes, separate beds, one bed can be turned into a sofa, some with upper and lower berths. Some have limited or no view. |
| | J Outside cabin | 6 | 8-11 m ² | With limited/no view, two-berth cabins with double bed, three-berth cabins with separate beds, one is an upper berth. |
| POLAR INSIDE | I Inside cabin | 3, 5 | 11-12 m ² | Separate beds, one bed can be turned into a sofa. |

Cabin category N and O - Please note that some outside cabins on upper decks can have obstructed views due to lifeboats.
 Cabin category P - Please note that these cabins can have obstructed views due to walking decks.
 Cabin category Q - Cabin 643 is adapted for guests with limited mobility.
 All information is subject to change.



Learn more about MS Nordlys

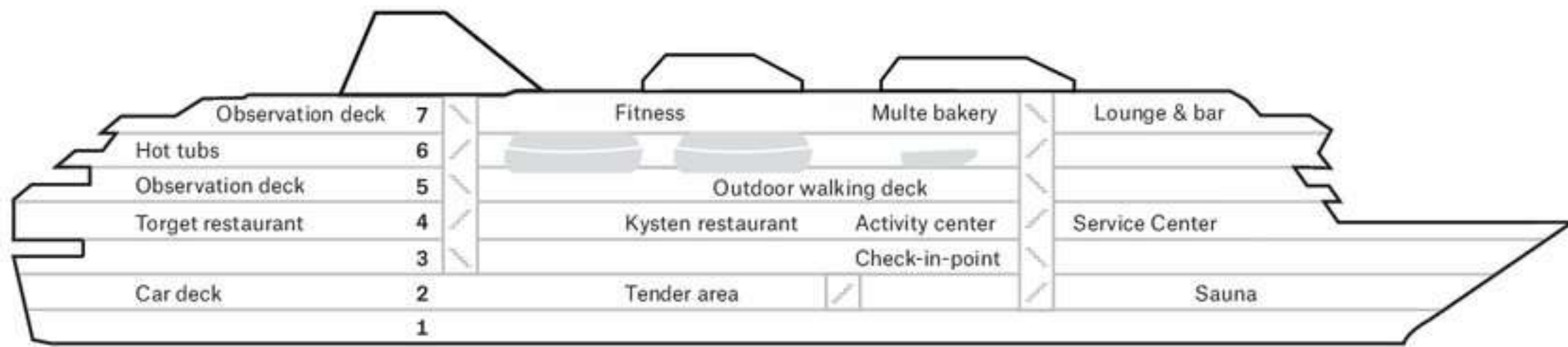

Deck

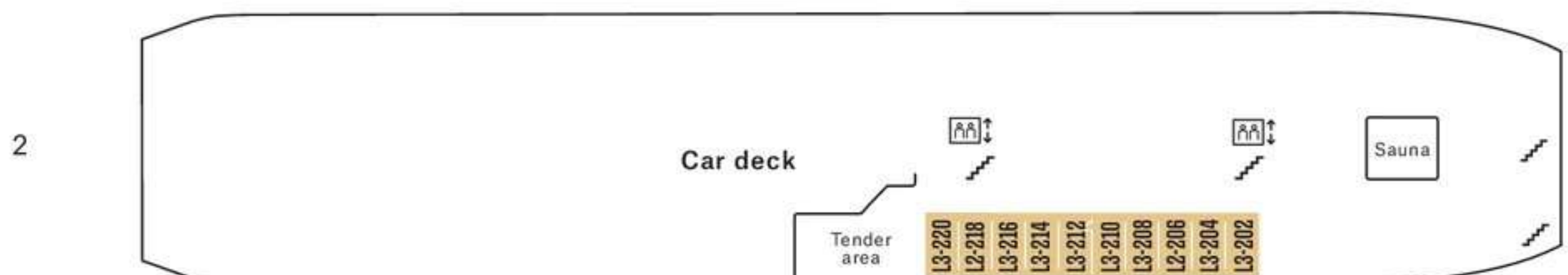
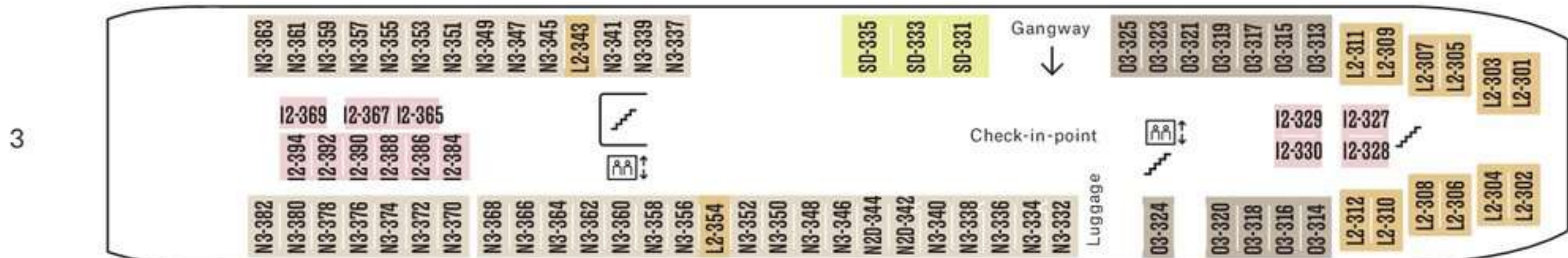
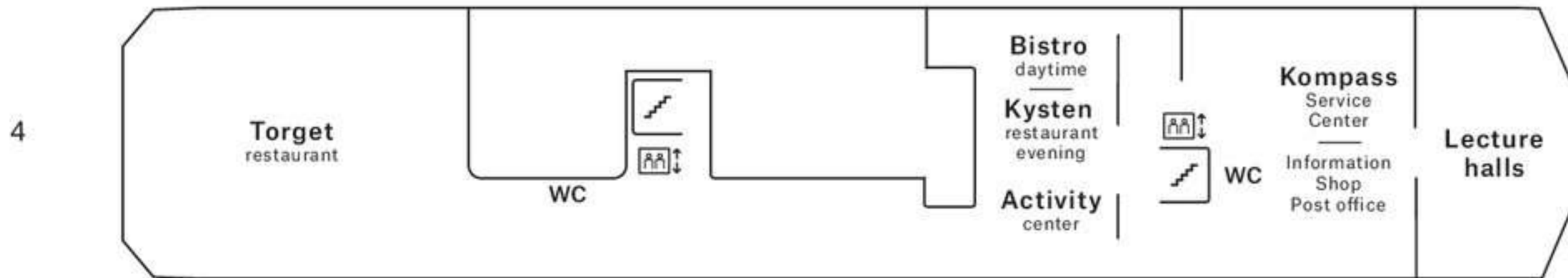
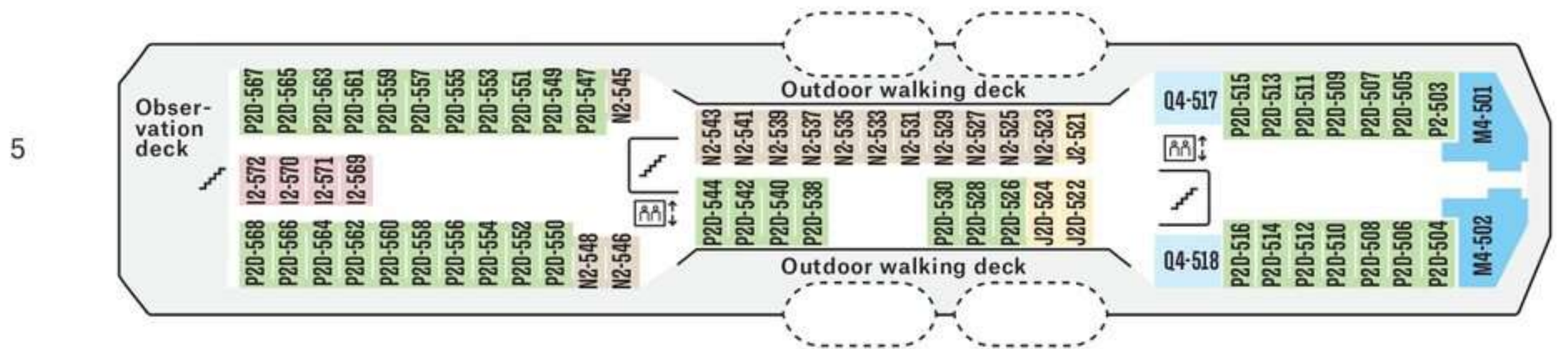
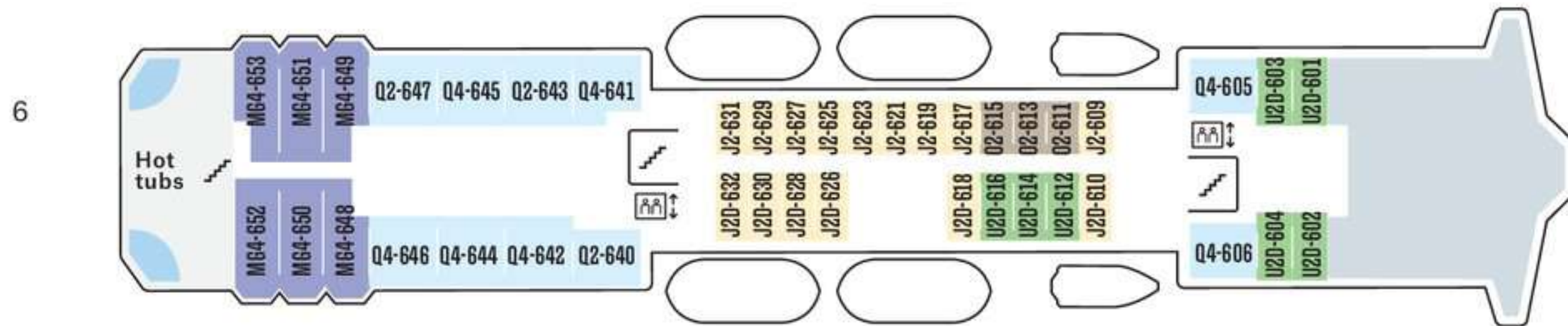
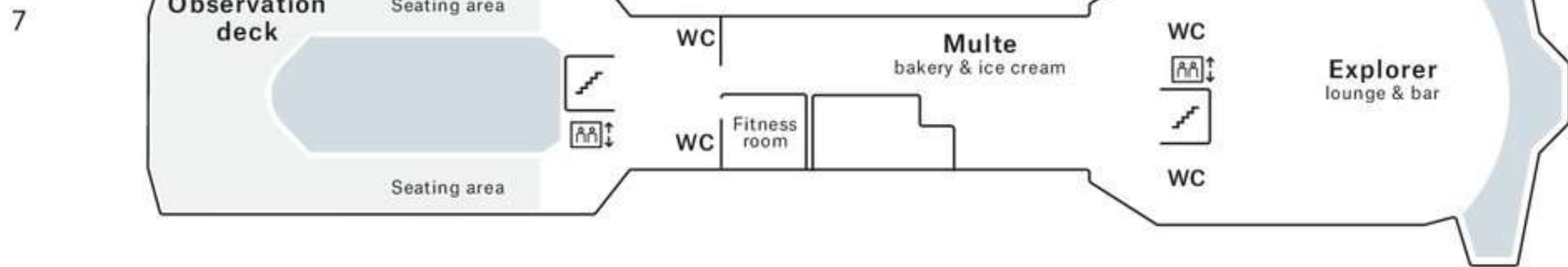

MS RICHARD WITH

It's only right that one of our ships should bear the name of our founder Captain Richard With. Thanks to his vision and entrepreneurism, we are The Original Norwegian Coastal Express, helping coastal communities survive and thrive.

The ship was refurbished recently as part of the largest upgrade project in our more-than-130-year history.

For relaxing

- Viewing lounge on the top floor
- Large outdoor observation deck and walk-around deck
- Sauna and two outdoor hot tubs
- Fitness room with large windows on the upper floor
- Lectures with the Expedition Team
- Onboard shop with essentials and souvenirs

Food and drink

- Main restaurant Torget for all three daily meals
- Comfort food with a Nordic twist in Brygga bistro
- À la carte restaurant Kysten for elegant fine dining
- Pastries, cakes, and ice cream in Multe bakery
- Explorer bar offering a variety of Norwegian drinks

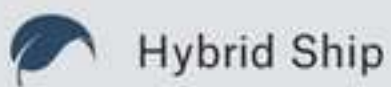

Hybrid Ship

Cabins: 199 and 19 suites **Gross tonnage:** 11,205
Year of construction: 1993 **Length:** 121.8 metres
Refurbished: 2023 **Beam:** 19.2 metres
Shipyard: Volkswagen, Germany **Service speed:** 15 knots



MS Richard With



Arctic Superior



Seating area

| | CATEGORY | | DECK | SIZE (m ²) | DESCRIPTION |
|-------------------|----------|---------------|------|------------------------|---|
| EXPEDITION SUITES | MG | Grand suite | 6 | 15-20 m ² | Double bed, one sofa bed, seating area, TV, safe, minibar, bay window with full view. |
| | M | Suite | 5 | 25-26 m ² | One or two-room suite, TV, kettle. |
| | Q | Mini suite | 6 | 17-23 m ² | One-room suite, seating area, TV, kettle. |
| ARCTIC SUPERIOR | U | Outside cabin | 6 | 10-12 m ² | Double bed, some with table, TV, kettle. |
| | P | Outside cabin | 5 | 11-12 m ² | Double bed, TV, kettle. |
| | O | Outside cabin | 3, 6 | 8-12 m ² | Separate beds, one bed can be turned into a sofa. |
| POLAR OUTSIDE | N | Outside cabin | 3, 5 | 8-12 m ² | Separate beds, one bed can be turned into a sofa. |
| | SD | Outside cabin | 3 | 17 m ² | Separate beds, one bed can be turned into a sofa. Adapted for guests with limited mobility. |
| | L | Outside cabin | 2, 3 | 8-12 m ² | With portholes, separate beds, one bed can be turned into a sofa, some with upper and lower berths. Some have limited or no view. |
| | J | Outside cabin | 5, 6 | 8-11 m ² | With limited/no view, two-berth cabins with double bed, three-berth cabins with separate beds, one is an upper berth. |
| POLAR INSIDE | I | Inside cabin | 3, 5 | 11-12 m ² | Separate beds, one bed can be turned into a sofa. |

Cabin category N and O - Please note that some outside cabins on upper decks can have obstructed views due to lifeboats.
 Cabin category P - Please note that these cabins can have obstructed views due to looking out onto the walking deck.
 Cabin category Q - Cabin 643 is adapted for guests with limited mobility.
 All information is subject to change.



Learn more about MS Richard With

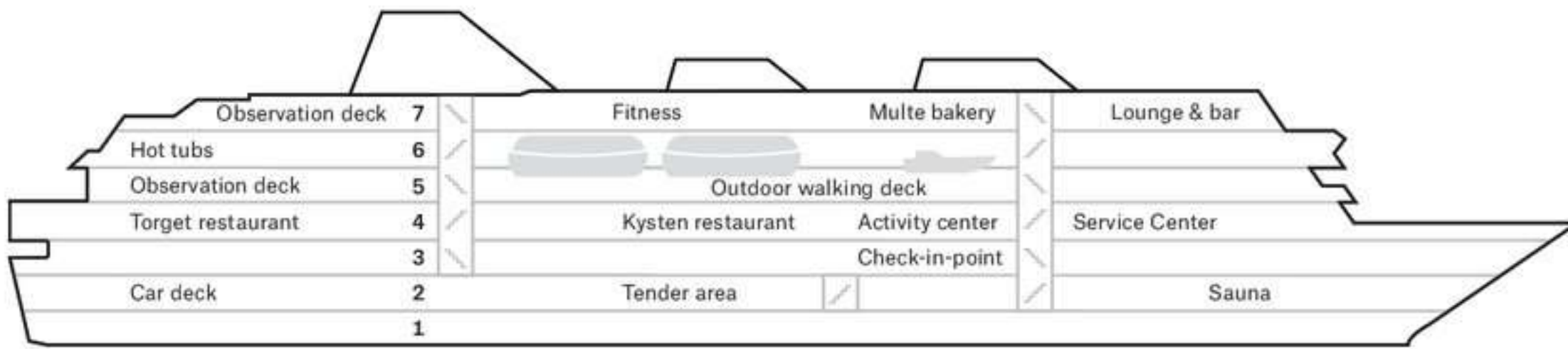

Deck

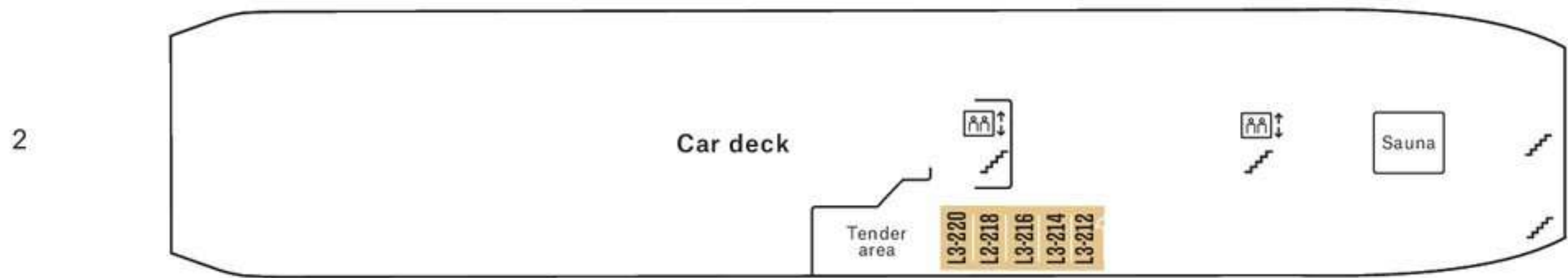
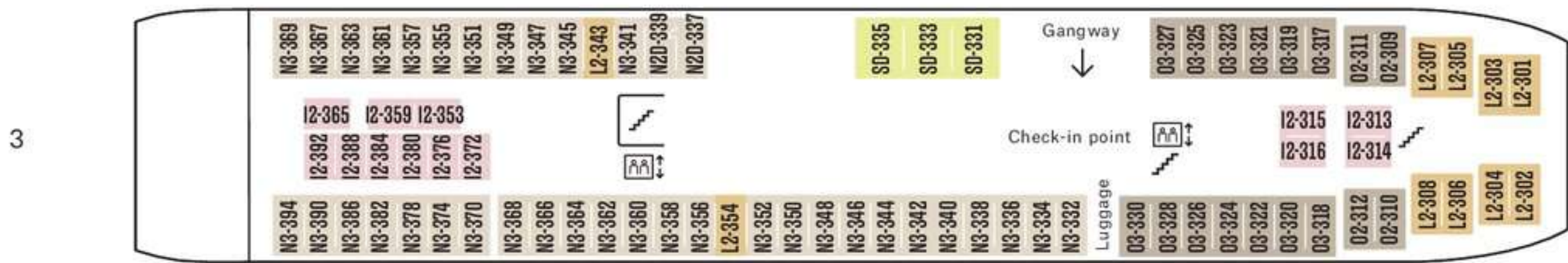
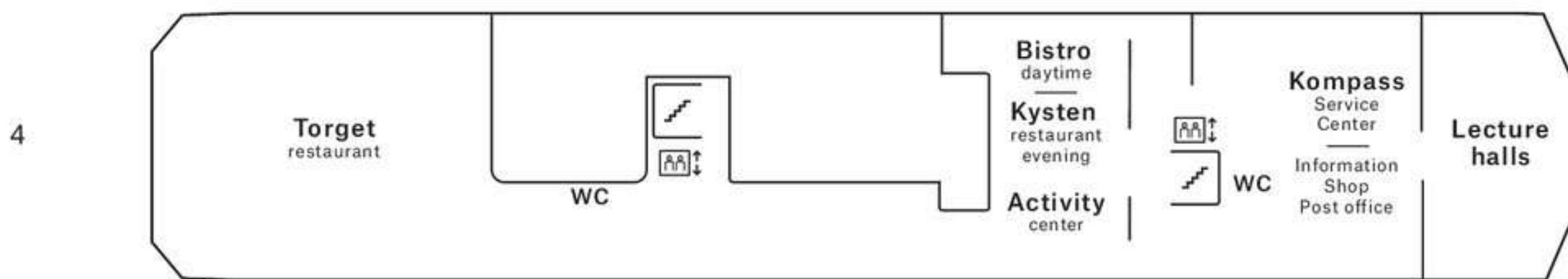
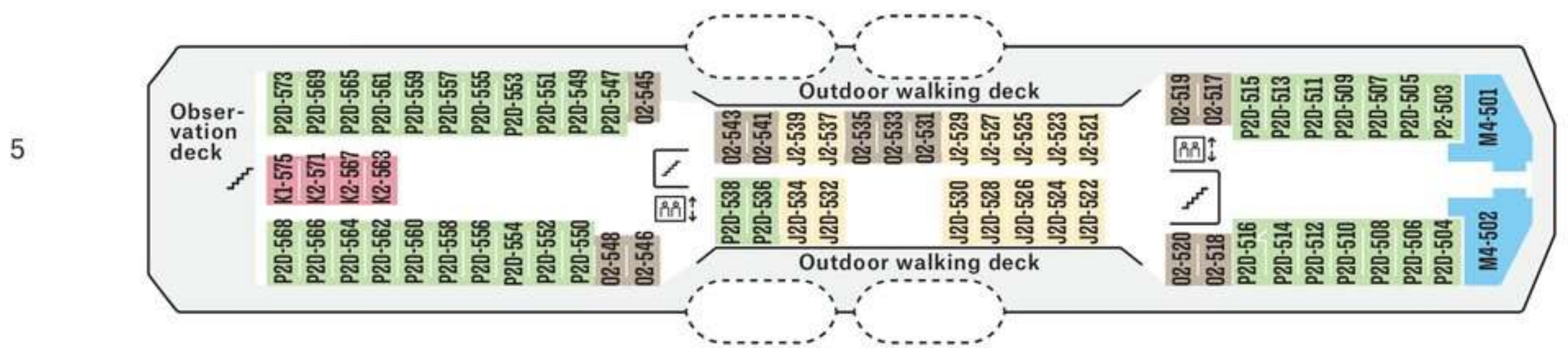
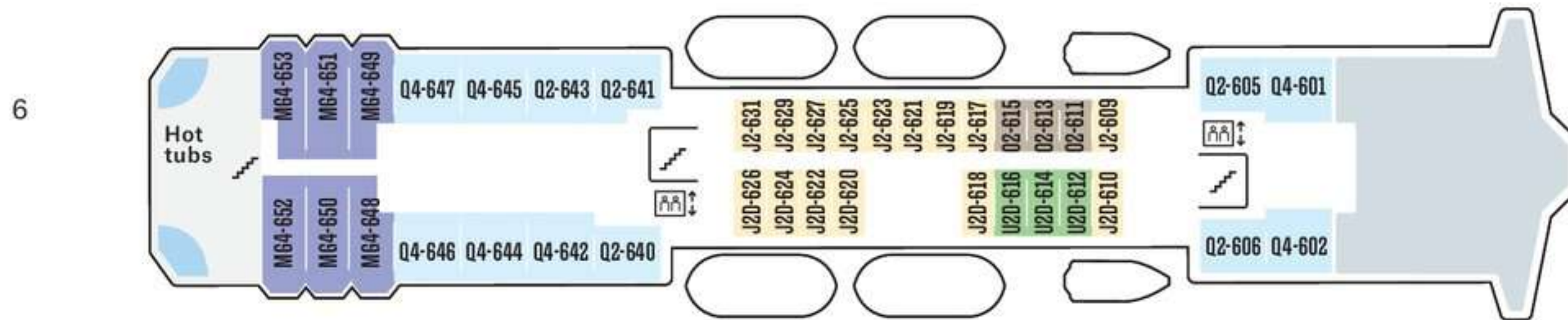
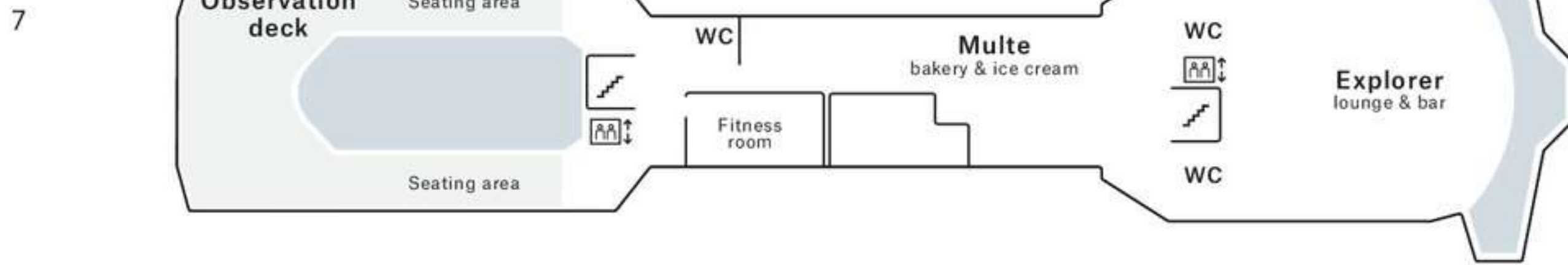

MS KONG HARALD

It's a true honour to have one of our ship's named after Norway's King Harald V.

The King is a skilled sailor, even representing Norway in sailing at the Olympic Games three times. In 2016, at the age of 78, he and his team finished second in the Sailing World Championships.

For relaxing

- Viewing lounge on the top floor
- Large outdoor observation deck and walk-around deck
- Sauna and two outdoor hot tubs
- Fitness room with large windows on the upper floor
- Lectures with the Expedition Team
- Onboard shop with essentials and souvenirs

Food and drink

- Main restaurant Torget for all three daily meals
- Comfort food with a Nordic twist in Brygga bistro
- À la carte restaurant Kysten for elegant fine dining
- Pastries, cakes, and ice cream in Multe bakery
- Explorer bar offering a variety of Norwegian drinks

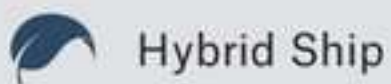

Hybrid Ship

Cabins: 221 and 2 suites **Gross tonnage:** 11,204
Year of construction: 1993 **Length:** 121.8 metres
Refurbished: 2016 **Beam:** 19.2 metres
Shipyard: Volkswerft, **Service speed:** 15 knots
 Germany



MS Kong Harald



Multe Bakery and ice cream



Polar Outside

| | CATEGORY | | DECK | SIZE (m ²) | DESCRIPTION |
|-------------------|----------|---------------|---------|------------------------|---|
| EXPEDITION SUITES | M | Suite | 5 | 28-30 m ² | One or two-room suite, TV, kettle. |
| | U | Outside cabin | 6 | 11-12 m ² | Double bed, TV, kettle. |
| ARCTIC SUPERIOR | P | Outside cabin | 5 | 8-11 m ² | Double bed, TV, kettle. |
| | O | Outside cabin | 3, 5, 6 | 7-13 m ² | Double bed, some with twin or triple beds. |
| | N | Outside cabin | 3 | 11-12 m ² | Double bed, some with twin or triple beds. |
| POLAR OUTSIDE | SD | Outside cabin | 3 | 17 m ² | Separate beds, one bed can be turned into a sofa. Adapted for guests with limited mobility. |
| | L | Outside cabin | 2, 3 | 10-12 m ² | With portholes. Double bed, some with twin or triple beds. Some cabins have limited or no view. |
| | J | Outside cabin | 5, 6 | 8-11 m ² | With limited/no view, double bed. |
| | K | Inside cabin | 5, 6 | 8-9 m ² | Separate beds, one bed can be turned into a sofa. |
| POLAR INSIDE | I | Inside cabin | 3 | 8-9 m ² | Separate beds, one bed can be turned into a sofa. Some with double bed. |

Cabin category N and O - Please note that some outside cabins on upper decks can have obstructed views due to lifeboats.
 Cabin category P - Please note that these cabins can have obstructed views due to walking decks.
 All information is subject to change.

All information is subject to change.



Learn more about MS Kong Harald

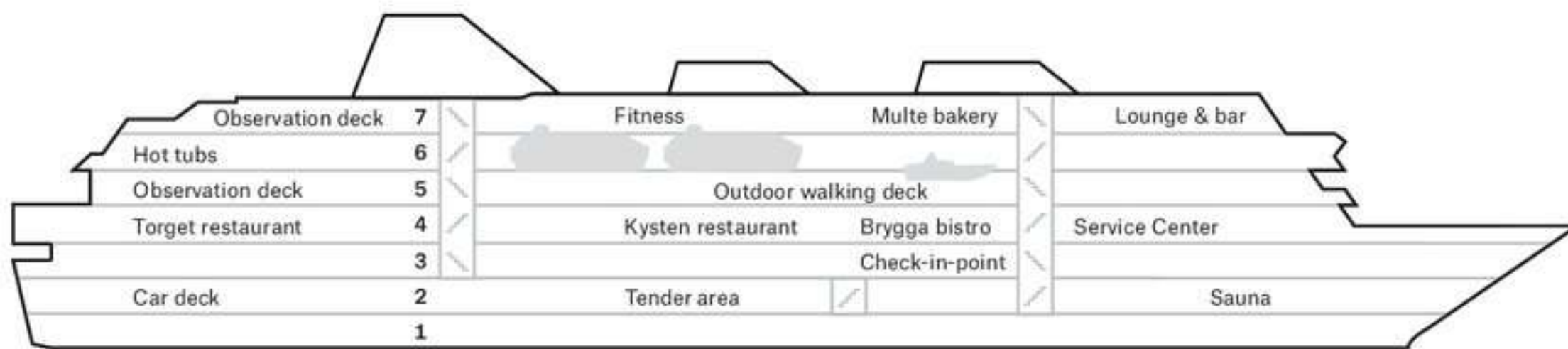

Deck

7

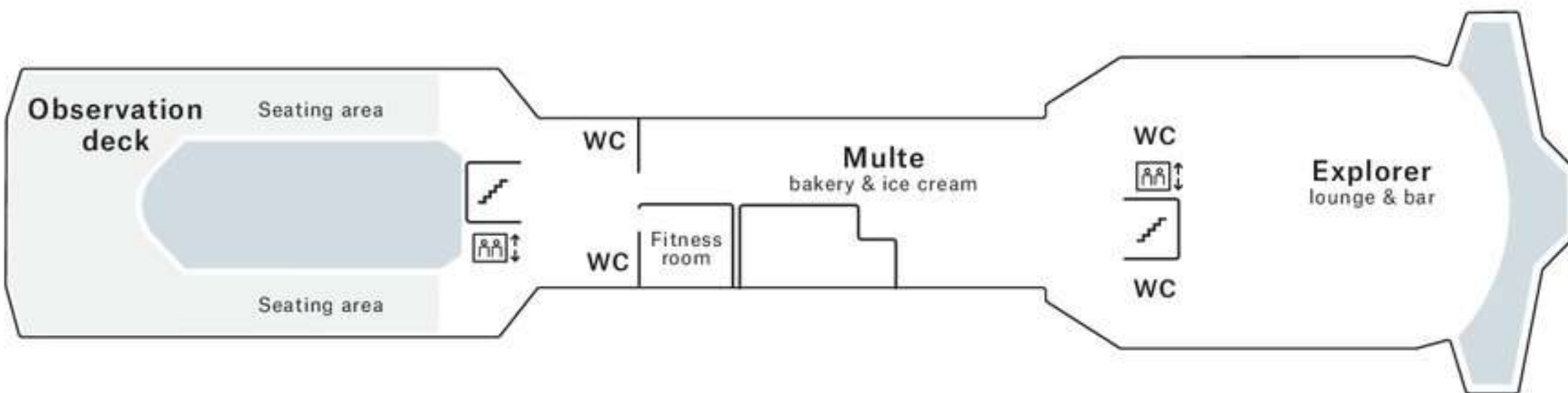

6

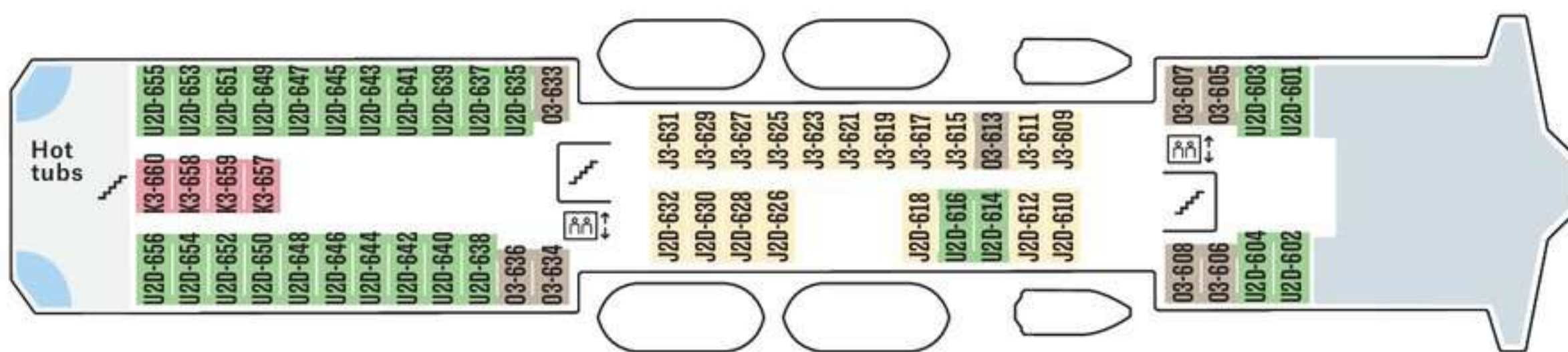

5

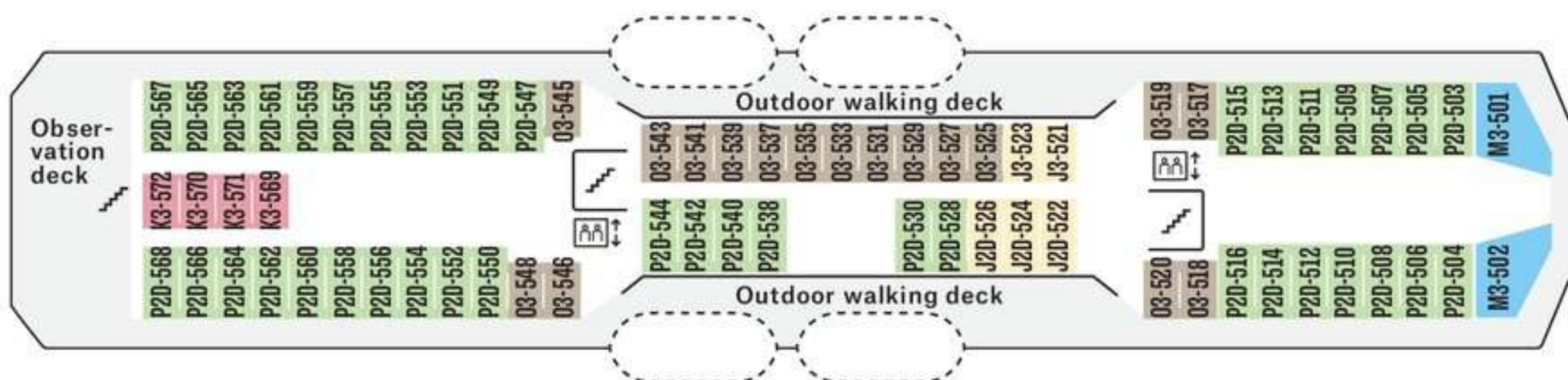

4

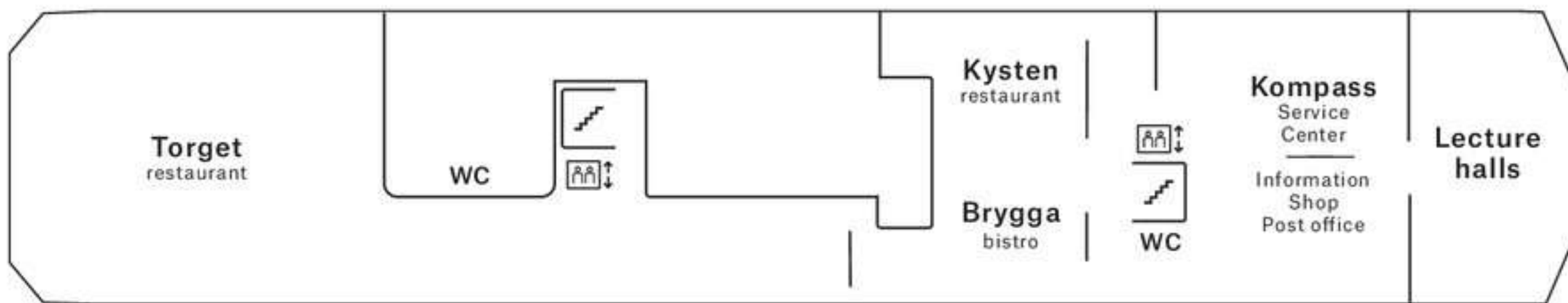

3

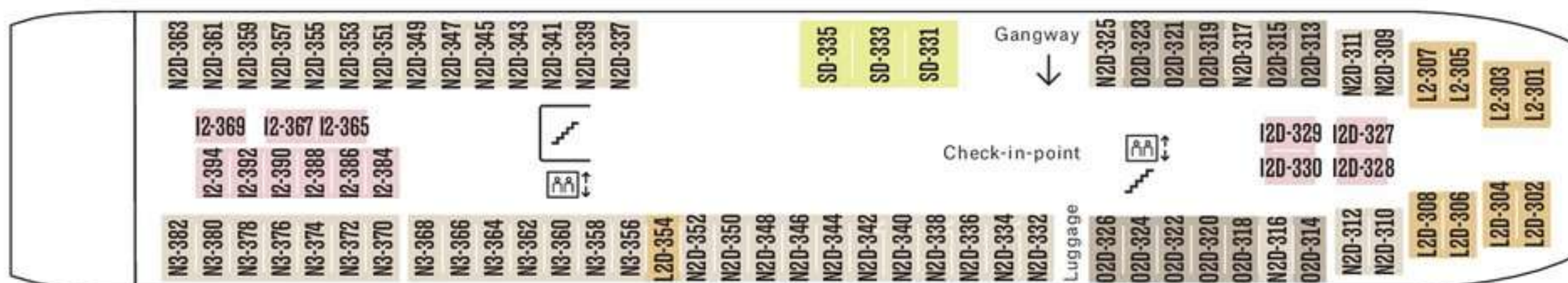

2

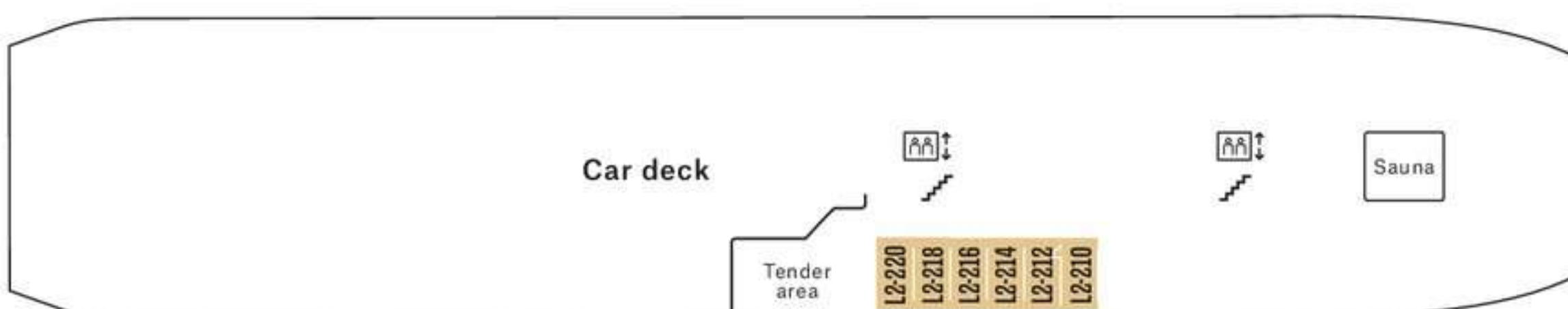

MS MIDNATSOL

This is one of our most well-known ships. It is named after the Midnight Sun, the phenomenon that occurs in northern Norway every summer when the sun doesn't set for 24 hours.

On board, you'll find the interiors reflect the ship's name with the use of warm colours and a classic Art Deco style.

For relaxing

- Double-storey viewing lounge on the top floors
- Large outdoor observation deck and walk-around deck
- Sauna with large windows on the upper floor
- Fitness room with large windows on the upper floor
- Lectures with the Expedition Team
- Onboard shop with essentials and souvenirs

Food and drink

- Main restaurant Torget for all three daily meals
- Comfort food with a Nordic twist in Brygga bistro
- À la carte restaurant Kysten for elegant fine dining
- Explorer bar offering a variety of Norwegian drinks

Cabins: 243 and 21 suites

Year of construction: 2003

Shipyard: Fosen Mek. Verk. (N)

Gross tonnage: 16,140

Length: 135.75 metres

Beam: 21.5 metres

Service speed: 15 knots



MS Midnatsol



Expedition Suite



Sauna

| | CATEGORY | DECK | SIZE (m ²) | DESCRIPTION |
|-------------------|------------------|---------|------------------------|---|
| EXPEDITION SUITES | MX Owner's suite | 8 | 44-45 m ² | Two-room suite with double bed, sofa bed, seating area, dining table, TV, stereo, kettle, minibar, private balcony. |
| | MG Grand suite | 7, 8 | 25-36 m ² | One or two-room suite with double bed, sofa bed, seating area, TV, stereo, kettle, minibar, some with bathtub, bay window or private balcony. |
| | M Suite | 7 | 23-24 m ² | One-room suite with double bed, sofa bed, TV, kettle, minibar, e and private balcony. |
| | Q Mini suite | 6, 7 | 16-24 m ² | Some with limited/no view, one-room suite with double bed, sofa bed, seating area, TV, kettle, minibar. |
| ARCTIC SUPERIOR | QJ Outside cabin | 6, 7 | 16-17 m ² | With limited/no view, separate beds, seating area, TV, kettle, minibar. |
| | YA Outside cabin | 6 | 16 m ² | Separate beds, one of which converts into a sofa, table, TV, kettle. Adapted for guests with disabilities. |
| | U Outside cabin | 7, 8 | 10-14 m ² | Double or separate beds, one of which converts into a sofa, some with table, TV, kettle. |
| | P Outside cabin | 6 | 10-11 m ² | Separate beds, one of which converts into a sofa, TV, kettle. |
| POLAR OUTSIDE | O Outside cabin | 4, 6 | 10-12 m ² | Separate beds, one of which converts into a sofa, TV, kettle. |
| | N Outside cabin | 4 | 11-13 m ² | Separate beds, one of which converts into a sofas, TV, kettle. |
| | L Outside cabin | 4 | 10-13 m ² | Some with limited/no view, separate beds, one of which converts into a sofa, portholes, TV, kettle. |
| | J Outside cabin | 6, 7 | 11-12 m ² | With limited/no view, separate beds, one of which converts into a sofa, TV, kettle. |
| POLAR INSIDE | I Inside cabin | 4, 6, 7 | 9-14 m ² | Separate beds, one of which doubles as a sofa, TV, kettle. |
| | K Inside cabin | 5, 6 | 8-9 m ² | Separate beds, one bed can be turned into a sofa, TV, hairdryer. |

Subject to change.



Learn more about MS Midnatsol

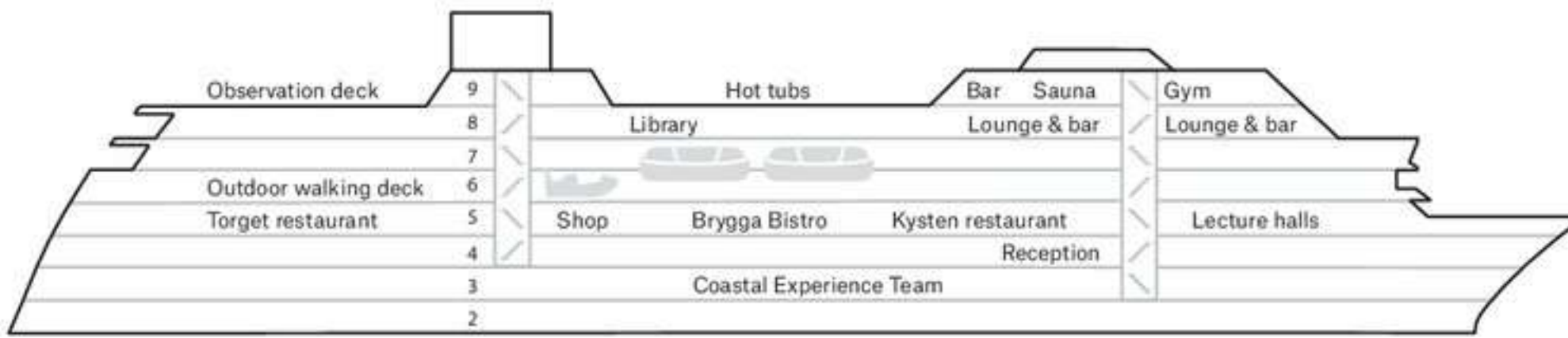

Deck

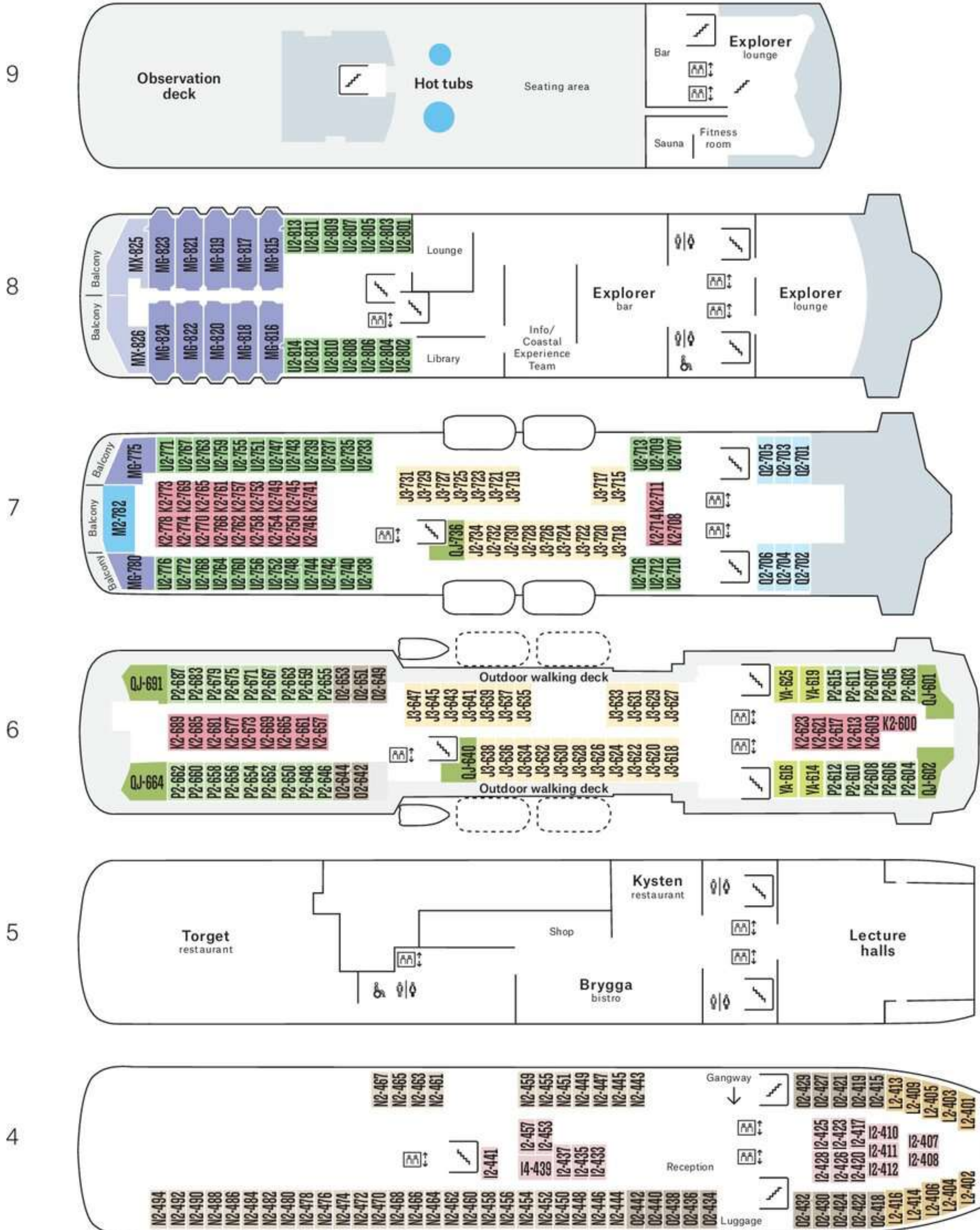

□ Indoor area □ Outdoor area



SAILING TIMETABLE

See the table below for the arrival and departures times of our ships for every port we visit, northbound and southbound.

| | | 1 NOV - 31 MAR | | 1 JUN - 31 AUG | | 1 APR - 31 MAY & 1 SEP - 31 OCT | | |
|--------------|--------------|----------------|-----------|----------------|-----------|---------------------------------|-----------|-------|
| DAY | PORT | ARRIVAL | DEPARTURE | ARRIVAL | DEPARTURE | ARRIVAL | DEPARTURE | |
| NORTHBOUND | 1 | Bergen | 14:45 | 20:30 | 14:45 | 20:30 | 14:45 | 20:30 |
| | 2 | Flore | 02:45 | 03:00 | 02:45 | 03:00 | 02:45 | 03:00 |
| | | Måløy | 05:15 | 05:30 | 05:15 | 05:30 | 05:15 | 05:30 |
| | | Torvik | 08:20 | 08:30 | 08:20 | 08:30 | 08:20 | 08:30 |
| | | Ålesund | 09:45 | 20:00 | 09:45 | 10:00 | 09:45 | 10:00 |
| | | Geirangerfjord | | | 14:25 | 14:45 | | |
| | | Urke | | | | | 12:15 | 15:45 |
| | | Ålesund | | | 19:00 | 20:00 | 18:00 | 20:00 |
| | 3 | Molde | 22:35 | 23:05 | 22:35 | 23:05 | 22:35 | 23:05 |
| | | Kristiansund | 02:45 | 03:00 | 02:45 | 03:00 | 02:45 | 03:00 |
| | | Trondheim | 09:45 | 12:45 | 09:45 | 12:45 | 09:45 | 12:45 |
| | 4 | Rørvik | 21:40 | 22:00 | 21:40 | 22:00 | 21:40 | 22:00 |
| Brønnøysund | | 01:35 | 01:45 | 01:35 | 01:45 | 01:35 | 01:45 | |
| Sandnessjøen | | 04:35 | 04:50 | 04:35 | 04:50 | 04:35 | 04:50 | |
| Nesna | | 06:00 | 06:10 | 06:00 | 06:10 | 06:00 | 06:10 | |
| Ørnes | | 10:00 | 10:10 | 10:00 | 10:10 | 10:00 | 10:10 | |
| Bodø | | 13:05 | 15:20 | 13:05 | 15:20 | 13:05 | 15:20 | |
| Stamsund | | 19:15 | 19:40 | 19:15 | 19:40 | 19:15 | 19:40 | |
| Svolvær | | 21:20 | 22:15 | 21:20 | 22:15 | 21:20 | 22:15 | |
| 5 | Stokmarknes | 01:30 | 01:40 | 01:30 | 01:40 | 01:30 | 01:40 | |
| | Sortland | 02:55 | 03:10 | 02:55 | 03:10 | 02:55 | 03:10 | |
| | Riseyhamn | 04:35 | 04:50 | 04:35 | 04:50 | 04:35 | 04:50 | |
| | Harstad | 07:10 | 07:45 | 07:10 | 07:45 | 07:10 | 07:45 | |
| | Finnsnes | 11:00 | 11:30 | 11:00 | 11:30 | 11:00 | 11:30 | |
| | Tromsø | 14:15 | 18:15 | 14:15 | 18:15 | 14:15 | 18:15 | |
| | Skjervøy | 22:10 | 22:25 | 22:10 | 22:25 | 22:10 | 22:25 | |
| 6 | Øksfjord | 01:50 | 02:00 | 01:50 | 02:00 | 01:50 | 02:00 | |
| | Hammerfest | 05:05 | 05:45 | 05:05 | 05:45 | 05:05 | 05:45 | |
| | Havøysund | 08:30 | 08:45 | 08:30 | 08:45 | 08:30 | 08:45 | |
| | Honningsvåg | 10:55 | 14:30 | 10:55 | 14:30 | 10:55 | 14:30 | |
| | Kjøllefjord | 16:40 | 17:00 | 16:40 | 17:00 | 16:40 | 17:00 | |
| | Mehamn | 18:55 | 19:15 | 18:55 | 19:15 | 18:55 | 19:15 | |
| | Berlevåg | 22:00 | 22:10 | 22:00 | 22:10 | 22:00 | 22:10 | |
| 7 | Båtsfjord | 00:00 | 00:30 | 00:00 | 00:30 | 00:00 | 00:30 | |
| | Vardø | 03:30 | 03:45 | 03:30 | 03:45 | 03:30 | 03:45 | |
| | Vadsø | 06:55 | 07:10 | 06:55 | 07:10 | 06:55 | 07:10 | |
| | Kirkenes | 09:00 | 12:30 | 09:00 | 12:30 | 09:00 | 12:30 | |
| SOUTHBOUND | 7 | Kirkenes | 09:00 | 12:30 | | | | |
| | | Vardø | 16:05 | 17:00 | | | | |
| | | Båtsfjord | 20:00 | 20:30 | | | | |
| | | Berlevåg | 22:25 | 22:35 | | | | |
| | 8 | Mehamn | 01:20 | 01:30 | | | | |
| | | Kjøllefjord | 03:25 | 03:35 | | | | |
| | | Honningsvåg | 05:45 | 06:00 | | | | |
| | | Havøysund | 08:00 | 08:15 | | | | |
| | | Hammerfest | 11:00 | 12:45 | | | | |
| | | Øksfjord | 15:50 | 16:05 | | | | |
| | | Skjervøy | 19:30 | 19:45 | | | | |
| | 9 | Tromsø | 23:45 | 01:30 | | | | |
| Finnsnes | | 04:20 | 04:40 | | | | | |
| Harstad | | 08:00 | 08:30 | | | | | |
| Riseyhamn | | 10:45 | 11:00 | | | | | |
| Sortland | | 12:30 | 13:00 | | | | | |
| Stokmarknes | | 14:15 | 15:15 | | | | | |
| 10 | Svolvær | 18:30 | 20:30 | | | | | |
| | Stamsund | 22:15 | 22:30 | | | | | |
| | Bodø | 02:30 | 03:30 | | | | | |
| | Ørnes | 06:25 | 06:35 | | | | | |
| 11 | Nesna | 10:25 | 10:35 | | | | | |
| | Sandnessjøen | 11:45 | 12:15 | | | | | |
| | Brønnøysund | 15:00 | 17:25 | | | | | |
| | Rørvik | 21:00 | 21:30 | | | | | |
| 12 | Trondheim | 06:30 | 09:30 | | | | | |
| | Kristiansund | 16:30 | 17:30 | | | | | |
| | Molde | 21:15 | 21:45 | | | | | |
| 12 | Ålesund | 00:30 | 01:20 | | | | | |
| | Torvik | 02:35 | 02:45 | | | | | |
| | Måløy | 05:45 | 06:00 | | | | | |
| | Flore | 08:15 | 08:30 | | | | | |
| | Bergen | 14:45 | 20:30 | | | | | |

THE WIND AND THE WAVES

The timings above are only approximate. Everything depends on the weather and the sea conditions at the time.

There may be times when it's not all plain sailing and we have to change the schedule or skip over certain ports. That's just part of the adventure of being at sea.

SHORT STOPS

At the ports where we only dock for 10 minutes, it may not be possible to get off the ship.

But you can still enjoy the sight of everyday life on the pier: cargo being loaded or unloaded, family and friends welcoming one of our local guests home.

TERMS AND CONDITIONS

TRUST US TO KEEP YOU SAFE

We always do our best to keep to our sailing schedule, but sometimes the sea or weather on the Norwegian coast has other plans.

When the wind is too wild or the fog is too thick, your safety comes first for us. Every time. Even if that means we have to change our itinerary or cancel excursions at the last minute.

WILDLIFE IS A SURPRISE

The Norwegian coast is a natural habitat, and we can't control what wildlife you get to see on your voyage with us. A lot depends on the season, migration patterns, and pure luck.

You might see Sea Eagles, seals, or whales. But you also might not. It's the excitement of not knowing that makes the times they do appear feel even more special.

NORTHERN LIGHTS PROMISE TERMS & CONDITIONS Subject to the following 'Terms and Conditions' in 2026/27

This offer applies to all new bookings of voyages of 11 days or more along the Norwegian coast aboard The Original Coastal Express and The North Cape Line. It applies to North Cape Line voyages departing between 20 September 2026 and 31 March 2027 and The Original Coastal Express voyages departing between 20 September 2026 and 31 March 2027.

A Northern Lights occurrence is defined as a sighting from the ship which is recorded by the ship's deck officers and which is announced to passengers on board. Northern Lights will be announced to your cabin or in another way as decided by the Master. An occurrence can last anything from a few minutes to a matter of hours, and the ship's decision as to whether the Northern Lights occurred is final.

We announce occurrences of the Northern Lights on board the ship and you have the option of announcements direct to your cabin or suite. We hope that you will experience seeing the Northern Lights whilst on your voyage with us of 11 days or more, but we cannot be held responsible if you don't.

We promise that in the event of there being no Northern Lights occurrence as defined above, you will receive a 6 or 7-day Original Coastal Express Classic Voyage, departing between 20 September 2027 and 31 March 2028 in an unspecified inside twin cabin on a full-board basis free of charge. You may upgrade to another grade of cabin subject to additional costs and availability. Please note that upgrading to suites with this offer may not be available.

We reserve the right to withdraw or amend the offer at any time. Please check at the time of booking as to the current status of the offer. The offer must be claimed and booked within 28 days from your return date. A choice of departure dates will be given.

The offer excludes flights, transfers, all onboard expenses, excursions, and luggage handling. The offer does not apply to re-scheduled or cancelled cruises. Bookings are non-transferable, non-changeable, and have no cash value. This offer is not combinable with claims for compensation, refunds or price reductions

1. YOUR CONTRACT

These Booking Terms and Conditions together with our privacy policy, the information contained in your brochure and any other written information that we brought to your attention before we confirmed your booking, form the basis of your contract with Hurtigruten Ltd whose registered office is at 210 Pentonville Road, London N1 9JY (Company No: 02865967), a company wholly owned by Hurtigruten Global Sales AS.

When you book an air package holiday or sailing with us the contract between us will exist as soon as you or your travel agent asks us to confirm your booking. We then become responsible to provide you with the voyage arrangements or air package holiday you have booked and you become responsible to pay for them, in each case subject to these terms and conditions. You will also become responsible to pay for any additional arrangements made by us on your behalf including International Flights not included in any air package, optional excursions, travel insurance or other arrangements requested by you and booked.

When you make a booking you guarantee you have the authority to accept and do accept on behalf of your party the terms of these booking conditions and accept responsibility for making all payments to us for all members of the party.

Furthermore, you consent to our use of your personal data in accordance with our Privacy Policy and you are authorised on behalf of all persons named on the booking to disclose their personal details to us, including where applicable, special categories of data (such as information on health conditions or disabilities and dietary requirements). We are unable to accept provisional or conditional bookings. We will send all documents and other information to you and you will be responsible for ensuring that all other members of the party are kept fully informed.

For Security reasons all adult passengers are required to provide contact information, including phone number and email. We will not issue travel documents before we have received this information.

A confirmation invoice which you should check as soon as you receive it will be sent on receipt of your deposit. If you wish to change or cancel any arrangements later you may have to pay an amendment or cancellation charge and additional costs (see clauses 6 and 7 below) which may be as much as the whole of the original price of your arrangements. Only one invoice and one set of documents will be issued. No verbal amendments may be made by either party to these written booking conditions; any change must be in writing signed by the Chief Executive of Hurtigruten Global Sales AS.

If your confirmed arrangements include a flight, we (or if you booked via an authorised agent of ours, that agent) will issue you with an ATOL Certificate and a confirmation. Upon receipt, if you believe that any details on the ATOL Certificate or confirmation or any other document are wrong you must advise us immediately.

If you book your holiday through a travel agent all communication must be through that agent. Please quote your booking reference number in all communications.

You are responsible for complying with

any visa or other entry requirements for you or any of your party who are not full European Union Passport Holders.

2. YOUR FINANCIAL PROTECTION

We provide financial security for flight inclusive Packages and ATOL protected flights. We do this by way of a bond held in favour of the Civil Aviation Authority (www.caa.co.uk; 45-59 Kingsway, London WC2B 6TE) under ATOL number 3584.

When you buy an ATOL protected flight or flight inclusive holiday from us you will receive an ATOL Certificate. This lists what is financially protected, where you can get information on what this means for you and who to contact if things go wrong. For further information, visit the ATOL website at www.atol.org.uk. The price of our flight inclusive Arrangements includes the amount of £2.50 per person as part of the ATOL Protection Contribution (APC) we pay to the CAA. This charge is included in our advertised prices. Not all holiday or travel services offered and sold by us will be protected by the ATOL Scheme. ATOL protection extends primarily to Customers who book and pay in the United Kingdom.

We, or the suppliers identified on your ATOL Certificate, will provide you with the services listed on the ATOL Certificate (or a suitable alternative). In some cases, where neither we nor the supplier are able to do so for reasons of insolvency, an alternative ATOL holder may provide you with the services you have bought (at no extra cost to you). You agree to accept that in those circumstances the alternative ATOL holder will perform those obligations and you agree to pay any money outstanding to be paid by you under your contract to that alternative ATOL holder. However, you also agree that in some cases it will not be possible to appoint an alternative ATOL holder, in which case you will be entitled to make a claim under the ATOL Scheme (or your credit card issuer where applicable).

If we, or the suppliers identified on your ATOL certificate, are unable to provide the services listed (or a suitable alternative, through an alternative ATOL holder or otherwise) for reasons of insolvency, the Trustees of the Air Travel Trust may make a payment to (or confer a benefit on) you under the ATOL scheme. You agree that in return for such a payment or benefit you assign absolutely to those Trustees any claims which you have or may have arising out of or relating to the non-provision of the services, including any claim against us, the travel agent (or your credit card issuer where applicable). You also agree that any such claims may be re-assigned to another body, if that other body has paid sums you have claimed under the ATOL scheme.

We provide financial security for holidays not including flights by way of a bond held with ABTA (www.abta.com; 30 Park Street, London SE1 9EQ).

If you book Arrangements other than an ATOL protected flight or Package from us, your monies will not be financially protected. Please ask us for further details.

3. PAYMENT

Once you have asked us to confirm your booking the total price of the arrangements you have booked is due and is payable as follows:

(i) If you book more than 90 days

before your scheduled departure date, a non-refundable deposit of 25% is due. The balance is due 90 days before your scheduled departure date. No second invoice will be sent. Travel documents will be issued 7 to 14 days prior to departure.

(ii) If you book less than 90 days before your scheduled departure date the full price is payable when you book.

Our preferred method of deposit payment is by bank debit card or credit card.

Balance payment may be made by cash, bank debit card, credit card or cheque (providing there is time to clear it to meet the payment schedule shown above - you should allow 5 working days for clearance from the time we receive it).

Bookings made within 90 days of departure require full payment at the time of booking and no refund is made if cancelled.

Your booking may be cancelled if we do not receive payment by the due date (we will not normally send reminders) and cancellation charges as set out under 'If You Cancel' (see below) will be payable by you.

4. FITNESS TO TRAVEL ON THE SHIP, PREGNANCY, DISABILITY OR REDUCED MOBILITY, MEDICAL/ MOBILITY EQUIPMENT

In order to ensure that the Carrier is able to carry passengers safely and in accordance with applicable safety requirements established by international, EU or national law or in order to meet safety requirements established by competent authorities including the ships flag state every Passenger warrants that he/she is fit to travel by sea and that his/her conduct or condition will not impair the safety of the ship or inconvenience the other passengers. Information on the trip's/holiday's general suitability for persons with reduced mobility is provided in the sales and marketing material for the trip/holiday and specific information is available upon request.

We reserve the right to require any Passenger to produce medical evidence of fitness to travel in order to assess whether that Passenger can be carried safely in accordance with applicable international, EU or national law. If we consider it necessary, we are entitled to administer a health questionnaire prior to boarding.

If it appears to us, the Master or the Company's nominated medical representative that a Passenger is for any reason unfit to travel, likely to endanger safety, or likely to be refused permission to land at any port, or likely to render the Carrier liable for Passenger maintenance, support or repatriation, then the Carrier or the Master shall have the right to take any of the following courses:

(i) Refuse to embark the Passenger at any port;

(ii) Disembark the Passenger at any port;

(iii) Transfer the Passenger to another berth or cabin;

(iv) If the Company's nominated medical representative considers it advisable, to place or confine him/her or to transfer the Passenger to a health facility at any port, at the Passenger's expense;

(v) To administer first aid and administer any drug, medicine or other substance or to admit and/or confine the Passenger to a hospital or other similar institution at any port provided that the ship's

nominated medical representative and/or Master considers that any such steps are necessary.

Where a Passenger is refused embarkation as a result of safety and/or fitness to travel, neither we nor the carrier shall be liable for any loss or expense occasioned to the passenger thereby, nor shall the passenger be entitled to any compensation from the Carrier.

Passengers who need assistance and/or have special requests or need special facilities or equipment with regard to accommodation, seating or services required or need to bring medical equipment must notify us at the time of booking. If there are any particular conditions, disabled or reduced mobility which require personal care or supervision then such personal care or supervision must be organised by the passenger and at the passenger's expense. Those passengers confined to wheelchairs must furnish their own standard size foldable wheelchairs but needn't be accompanied by a travelling companion. Unless we and or the Carrier agree otherwise and in writing Passengers are limited to bringing 2 items of such mobility or medical equipment on board per cabin with a total value not exceeding £2,200. All equipment must be capable of being carried safely and must be declared before the sailing. The Carrier may decline to carry such equipment where it is not safe to do so or where it has not been notified in time to enable a risk assessment to be carried out.

Pregnant women are welcome onboard our cruises, however, we recommend seeking medical advice prior to travel at any stage of the pregnancy. For the sake of the mother and baby, a medical certificate may also be needed at certain stages of the pregnancy.

Up to 4 weeks before the due date: A medical certificate is not needed. Between 2-4 weeks before the due date: A medical certificate is needed to travel with us.

Less than 2 weeks before the due date: For the sake of the mother-to-be and the baby, pregnant mothers are not permitted to travel with us less than 2 weeks before the due date.

5. A - PRICES

All Voyage prices shown in this brochure are in pounds sterling and are per person based on full occupancy of the cabin accommodation unless otherwise stated.

Single/Sole occupancy of cabins with more than one berth is at our discretion as single/sole use of multiple berth cabins will be limited.

We reserve the right to amend the price of unsold holidays at any time and correct errors in the prices of confirmed holidays. You will be advised of the current price of the voyage or air package holiday you wish to book before your contract is confirmed. The price of your confirmed holidays is subject at all times to variations in:

(i) the price of transportation resulting from the cost of fuel or other power sources;

(ii) the level of taxes or fees applicable to the holiday imposed by third parties not directly involved in the performance of your holiday, including tourist taxes, landing taxes or embarkation or disembarkation

fees at ports and airports; or (iii) the exchange rates relevant to your package.

You will be charged for the amount of any increase in accordance with this clause and, where this is necessary, we will notify you of the relevant adjustments by issuing a new invoice. However, if this means that you have to pay an increase of more than 8% of the total price of your confirmed holiday (excluding any amendment charges and/or additional services or travel arrangements), you will have the option of accepting the price increase and paying the requested amount, accepting a change to another holiday if we are able to offer one (if this is of equivalent or higher quality you will not have to pay more but if it is of lower quality you will be refunded the difference in price), or cancelling and receiving a full refund of all monies paid to us, except for any amendment charges and/or additional services or travel arrangements not forming part of your package. Should you decide to cancel for this reason, you must exercise your right to do so within 14 days from the issue date on your new invoice. As Hurtigruten is a member of ABTA, Hurtigruten will absorb an amount equal to 2% of the holiday cost before passing on any surcharge.

Should the price of your voyage or air package holiday go down due to changes above then any refund due will be paid to you, less an administration fee of £50 per person

Please note that travel arrangements are not always purchased in local currency and some apparent changes have no impact on the price of your travel due to contractual or other protection in place.

There will be no change made to the price of your confirmed holiday within 20 days of your departure nor will refunds be paid during this period.

5. B - VOYAGE AND AIR PACKAGE HOLIDAY

Prices Do Not Include:

- Travel Insurance
- Luggage Handling
- International Flights except where included in the Air Package Holiday Price
- Optional Excursions
- Gratuities

Optional Excursions booked before you travel or local excursions or other activities that you may choose to book and pay for whilst on holiday are not part of your voyage or air package holiday arrangements provided by us nor are we agents for the provider of the service. For any excursion or other activity you book before departure or with which you are assisted in arranging whilst on holiday, your contract will solely be with the supplier of the excursion or activity and not with Hurtigruten. We are not responsible for the provision of your excursion or activity or for anything that happens during the course of its provision by the supplier.

6. IF YOU CHANGE OR TRANSFER YOUR BOOKING

If you wish to change your travel arrangements after they have been confirmed we will do our utmost to help but it may not always be possible. Any request for changes to be made must be in writing by the person who made the booking or your travel agent. You will be asked to pay an administration charge of £50 per person and any further cost we incur in making this alteration. NB:

most airlines will charge a fee for ticket changes. Costs may increase the closer to the departure date that changes are made. For example, the transfer within 60 days of departure of arrangements involving a scheduled flight will mean the cancellation and re-booking of this flight and a significant additional charge.

If you change the number of people in your party, the price of the arrangements will be recalculated for the new party size e.g. this may mean that accommodation is under-occupied and each member of the party may have to pay an increased price.

Any increase in price caused by changes you have requested is not a cancellation charge even though it may arise because a member of your party has cancelled. Any change by you to your confirmed arrangements after departure is in all cases subject to availability and any relevant costs.

Transfer of Booking: If any member of your party is prevented from travelling, that person(s) may transfer their place to someone else, subject to the following conditions:

- that person is introduced by you and satisfies all the conditions applicable to the Arrangements;
- we are notified no less than 7 days before departure;
- you pay any outstanding balance payment, an administration fee of £60 per person as well as any additional fees, charges or other costs arising from the transfer; and
- the transferee agrees to these booking conditions and all other requirements applicable to the holiday booking.

You and the transferee remain jointly and severally liable for payment of all sums.

If you are unable to find a replacement, cancellation charges as set out will apply in order to cover our estimated costs. Otherwise, no refunds will be given for passengers not travelling or for unused services.

7. IF YOU CANCEL BEFORE DEPARTURE

You, or any member of your party, may cancel your travel arrangements at any time. Written confirmation from the person who made the booking or your travel agent must be received by us via email or our offices. For postal cancellations, we recommend recorded delivery. Cancellation takes effect the day we receive your letter or email. Since we incur costs in relation to your arrangements from the time we confirm your booking you will have to pay the applicable cancellation charges as shown in the table below (which also applies if we cancel because you have failed to make payments on time - see 'Payment' section) together with the cost of any air fare for which we have had to pay at the time of the booking and will be payable immediately on cancellation.

NORWEGIAN COASTAL VOYAGES:

| When the cancellation letter is received by us before departure | Charges as a % of the total holiday cost (excl. insurance premiums) |
|---|---|
| - 90 or more days | 25% |
| - 60-89 days | 40% |
| - 28-59 days | 70% |
| - 14-27 days | 90% |
| - Less than 14 days | 100% |

TERMS AND CONDITIONS

If you have to cancel for a reason covered by your travel insurance you may be able to reclaim the cancellation charges, less applicable excess. Insurance premiums are not refundable.

8. IF YOU CANCEL DUE TO FORCE MAJEURE

You have the right to cancel your confirmed holiday before departure without paying a cancellation charge in the event of unavoidable and extraordinary circumstances occurring at your holiday destination or its immediate vicinity and significantly affecting the performance of the holiday or which significantly affects transport arrangements to the destination. In these circumstances, we shall provide you with a full refund of the monies you have paid but we will not be liable to pay you any compensation. Please see clause 10 for more information on Force Majeure.

9. IF WE CHANGE OR CANCEL YOUR BOOKING

We reserve the right to change any of the details, and correct any errors in this brochure or invoices at any time. If changes are made before you have made your booking we will advise you before we confirm your arrangements.

We reserve the right in any circumstances to cancel your travel arrangements (for example if a minimum number of participants for a particular travel arrangements not reached, we may have to cancel it) and to change airline, aircraft types, vessels and itineraries without liability for any subsequent loss. Even after we have confirmed your booking we may have to cancel or make alterations to your booking but we will not cancel your travel arrangements less than 60 days before your departure except for reasons of force majeure or failure by you to pay the final balance in full.

Most alterations will be minor and while we will do our best to notify you or your travel agent of any changes as soon as reasonably possible if there is time before your departure, we will have no other liability to you.

Occasionally we may have to make a significant change to your confirmed arrangements. If we have to make a Significant Change we will notify you as soon as possible and you may either:

a) accept the Significant Change and the contract between us will then be varied to incorporate the change; or

b) take alternative arrangements altogether (subject to availability). If the alternative arrangements selected are a lower price than those originally confirmed the difference will (if already paid) be refunded to you; or

c) withdraw from the booking completely in which case we will, as soon as possible, refund all money paid to us.

You must inform us of your decision as soon as reasonably possible and not later than 7 days of being informed of the alteration. If you choose (a) or (b) above, you will receive as compensation a credit towards the cost of your arrangements, or any alternative selected, as per the amount shown in Scale A below. If you choose (c) we will pay you compensation shown in Scale B below. In all cases we will have no liability for any other or greater compensation or for expenses or losses incurred.

Period before departure date notification given by us. Credit/

Compensation per fare-paying passenger (excluding infants)*

| | Scale A | Scale B |
|-------------------|---------|---------|
| 0-7 days | £50 | £25 |
| 8-14 days | £40 | £20 |
| 15-28 days | £30 | £15 |
| 29-42 days | £20 | £10 |
| 43-59 days | £10 | £5 |
| More than 60 days | | Nil |

*The compensation shown above applies to full fare paying adults only. Children or others travelling at concessionary rates will receive compensation pro rata based on the concessionary price against the full adult price as shown on the confirmation.

IMPORTANT NOTE: We will not pay you compensation in the following circumstances:

- where we make a change that is not a Significant Change;
- where we make a Significant Change or cancel your arrangements more than 60 days before departure;
- where we have to cancel your arrangements as a result of your failure to make full payment on time;
- where the change or cancellation by us arises out of alterations to the confirmed booking requested by you;
- where we are forced to cancel or change your arrangements due to Force Majeure (see clause 10).

Please note: where arrangements with a higher price than the original arrangements are offered by us and accepted by you, the difference in price will be deducted from any compensation payable. In no case will we pay compensation if the arrangements offered by us and accepted by you are of a higher price than those originally booked by you and in the same location where no additional payment is made by you.

If we become unable to provide a significant proportion of the arrangements that you have booked with us after you have departed, we will make alternative arrangements for you at no extra charge and, if appropriate in all the circumstances, will pay you reasonable compensation.

A flight or ship delay does not constitute a change to holiday arrangements.

10. FORCE MAJEURE

Except where otherwise expressly stated in these Booking Conditions we are unable to accept liability or pay compensation where the performance or prompt performance of our contractual obligation is prevented or affected by reason of circumstances amounting to 'force majeure' i.e. any event which we or the supplier(s) of the service(s) could not, even with due care foresee or avoid. Such events may include, but are not limited to, war, threat of war or civil commotions, riots, terrorist activity, industrial dispute, natural or nuclear disaster, adverse weather, fire, flood, drought, government action, airport and port regulations and closures, technical transportation problems, maintenance to vessels, scheduling of transport and similar events outside our control.

11. COMPLAINT PROCEDURE

If there is a problem during your holiday, you must report it on board immediately or to the relevant airline, ground handler,

hotelier or other supplier, so that prompt efforts can be made to resolve the problem. In the unlikely event that a problem cannot be resolved at the time and you wish to complain, you must send us full written details within 28 days of your return.

Failure to take either or both of these steps will prejudice our ability to resolve your problem and / or investigate it fully. In consequence, any right to compensation you may have will be extinguished or, at the very least, substantially reduced.

Where the port of embarkation for your sailing is in the EU then any complaints relating to EU Regulation 1177/2010 on Passenger Rights when travelling by Sea and Inland waterways must be made to us in writing no later than 2 months after return from travel or the date on which the service complained of was performed. We will provide a final reply within 2 months. You must supply full details to enable us to deal with your complaint.

Please note that we offer an Alternative Dispute Resolution service through our ABTA membership. Please see clause 12 for further details. You can also access the European Commission Online Dispute (ODR) Resolution platform at <http://ec.europa.eu/consumers/odr/>. This ODR platform is a means of registering your complaint with us; it will not determine how your complaint should be resolved.

12. ABTA

We are a Member of ABTA, membership number V7545. We are obliged to maintain a high standard of service to you by ABTA's Code of Conduct. We can also offer you ABTA's scheme for the resolution of disputes which is approved by the Chartered Trading Standards Institute. If we can't resolve your complaint, go to www.abta.com to use ABTA's simple procedure. Further information on the Code and ABTA's assistance in resolving disputes can be found on www.abta.com.

13. OUR LIABILITY TO YOU

(i) We will accept responsibility for those arrangements we agree to provide or arrange for you as an 'organiser' under the Package Travel, Package Holidays and Package Tours Regulations 1992 and the EU Directive 2015/2302 on Package Travel (and subsequent UK regulations) as set out below. Subject to these booking conditions, if we or our suppliers perform or arrange your contracted holiday arrangements negligently, taking into consideration all relevant factors, we will pay you reasonable compensation. The level of such compensation will be calculated taking into consideration all relevant factors such as but not limited to: following the complaints procedure as described in these conditions and the extent to which ours or our employees' or suppliers' negligence affected the overall enjoyment of your holiday. Please note that it is your responsibility to show that we or our supplier(s) have been negligent if you wish to make a claim against us.

(ii) Where death or personal injury or loss of or damage to property occurs during carriage by air or by sea then liability and the extent of damages recoverable will be dealt with by International Conventions as set out in paragraphs (v) and (vi) and not otherwise.

(iii) As set out in these booking conditions we limit the maximum amount we may

have to pay you for any claims you may make against us which do not involve personal injury, illness or death. Except where loss of and/or damage to luggage or personal possessions is concerned if we are found liable to you on any basis the maximum amount we will have to pay you is twice the price (excluding insurance premiums and amendment charges) paid by or on behalf of the person(s) affected in total unless a lower limitation applies to your claim under clause 13 (vi) below.

(iv) Where any claim or part of a claim (including those involving death or personal injury) concerns or is based on any travel arrangements (including the process of getting on and/or off the transport concerned) provided by any air, sea, rail or road carrier or any stay in a hotel, the maximum amount of compensation we will have to pay you will be limited. The most we will have to pay you for that claim or that part of a claim if we are found liable to you on any basis is the most the carrier or hotel keeper concerned would have to pay under the international convention or regulation which applies to the travel arrangements or hotel stay in question. (for example, the Warsaw Convention as amended or unamended and the Montreal Convention for international travel by air and/or for airlines with an operating licence granted by an EU country, the EC Regulation on Air Carrier Liability No 889/2002 for national and international travel by air, the Athens convention for international travel by sea).

Please note: Where a carrier or hotel would not be obliged to make any payment to you under the applicable International Convention or Regulation in respect of a claim or part of a claim, we similarly are not obliged to make a payment to you for that claim or part of the claim. When making any payment, we are entitled to deduct any money which you have received or are entitled to receive from the transport provider or hotelier for the complaint or claim in question. Copies of the applicable International Conventions and Regulations are available from us on request. We do not have any liability to you by virtue of the Regulation 261/2004 which applies solely to the operating carrier. Any liability we may have to you under our contract with you, arising out of the same facts, is limited to the remedies provided under the Regulation as if (for this purpose only) we were a carrier; any sums you receive from the carrier will be deducted from any amount due from ourselves.

(v) Travel by sea is governed by the provisions of the Convention Relating to the Carriage of Passengers and their Luggage by Sea 1974 as amended in 1976 ('The Athens Convention') and where applicable from 1 January 2013 EU Regulation 392/2009 relating to the Liability of carriers of passengers by sea in the event of accidents ('EU Regulation 392/2009'). For the purposes of the Athens Convention and EU Regulation 392/2009 we are the Contracting Carrier.

The Athens Convention and EU Regulation 392/2009 limit the Carriers' liability for death or personal injury or loss or damage to luggage and makes special provision for valuables. It is presumed that luggage has been delivered to you undamaged unless written notice is given by us and/or the performing Carrier.

a) in the case of apparent damage, before or at the time of disembarkation or redelivery; or

b) in the case of damage which is not apparent or of loss, within 15 days from the date of disembarkation or redelivery or from the time when such redelivery should have taken place.

Damages for cabin luggage payable by the Carrier are limited up to the Athens Convention limit of 833 SDRs or 2250 SDRs if EU Regulation 392/2009 applies. Limits shall be reduced in proportion to any contributory negligence by the Client and by the maximum deductible specified in Article 8(4) of the Athens Convention or EU Regulation 392/2009.

In so far as we may be liable to a Client in respect of claims arising out of carriage by sea, we shall be entitled to all the rights, defences, immunities and limitations available, respectively, to the actual carrier and under the relevant Conventions and nothing in these Booking Conditions shall be deemed as a surrender thereof. To the extent that any provision in these Booking Conditions is made null and void by the Athens Convention or EU Regulation 392/2009 or any legislation compulsorily applicable or is otherwise unenforceable, it shall be void to that extent but not further.

Any liability in respect of death and personal injury and loss of and damage to luggage which we may incur to you shall always be subject to the limits of liability contained in the Athens Convention or EU Regulation 392/2009 for death/personal injury of 46,666 Special Drawing Rights (SDR) or 300,000 SDR under Athens Convention or 400,000 SDRs under EU Regulation 392/2009 except in the case of liability for war or terrorism 250,000 SDRs. We are not liable for valuables, monies or other securities including jewellery and watches. If they have been deposited with the reception desk on the ship for safe keeping and a receipt issued then in those limited circumstances the Carriers liability will be as set out in the Athens Convention or EU Regulation 392/2009. The use of safes on board a Vessel is not a deposit with the ship or with the company under the Athens Convention or EU Regulation 392/2009 or otherwise. The limits are 1200 SDRs pursuant to Athens or 3,375 SDRs pursuant to EU Regulation 392/2009.

(vi) Where there is any loss of or damage to property including luggage which is not covered by any international convention and where liability is not limited by reference to any enactment, terms of conditions, then any legal liability that we may have for any such losses or damage will not exceed £500 per guest.

(vii) You must provide ourselves and our insurers with all assistance we may reasonably require. You must also tell us and the supplier concerned about your claim or complaint as set out in clause 11 above. If asked to do so, you must transfer to us or our insurers any rights you have against the supplier or whoever else is responsible for your claim or complaint (if the person concerned is under 18, their parent or guardian must do so). You must also agree to cooperate fully with us and our insurers if we or our insurers want to enforce any rights which are transferred.

(viii) Please note, we cannot accept any liability for any damage, loss or expense or other sum(s) of any description: (a) which on the basis of the information given to us by you concerning your booking prior to our accepting it, we could not have foreseen you would suffer or incur if we breached our contract with you; or (b) relate to any business.

(ix) We will not accept responsibility for services or facilities which do not form part of our agreement or where they are not advertised in our brochure. For example any excursion you book whilst away, or any service or facility which your hotel or any other supplier agrees to provide for you.

14. YOUR RESPONSIBILITIES AND INDEMNITY

When you book arrangements with us you accept responsibility for the proper conduct of yourself and your party. If your actions or omissions cause damage to any property in the provision of the contracted arrangements, or cause delay or diversion to any flight or other means of transportation, you agree to fully indemnify us against any claim (including professional fees and legal costs) made against us by or on behalf of the owner of such property or the operator of the flight or other means of transportation. The Captain of an aircraft or Master of a ship has authority over the aircraft/ship and passengers at all times when they are boarding or on board. There will be no liability on our part, or that of any supplier, for any refund, compensation, or costs thus incurred. Additionally, we will have the right to recover full costs resulting from the incident from the passenger.

At any port or place we may refuse to embark or may disembark any passenger who, in the opinion of the ship's authorized personnel, might be excluded from landing at further destinations by local authorities or who may be suffering from any contagious or infectious disease, or whose presence may be detrimental to the wellbeing of passengers or crew. In cases of quarantine of the ship, or individual passengers (passengers may be required to remain in their cabin or as instructed by authorised personnel on board if they or any other occupant of the accommodation presents any symptoms or may be considered to put other passengers at risk) we will not be liable for expenses thus caused and in such cases as above there will be no entitlement to any refund or compensation and we will have no liability for costs incurred as a result.

Your specific passport and visa and health requirements and other immigration requirements are your responsibility and you should confirm these with the relevant Embassies and/or Consulates. We do not accept responsibility if you cannot travel because you have not complied with the latest requirements. If you have made independent travel arrangements you accept responsibility for joining the ship in good time, regardless of any change to the sailing time or date, or to the itinerary. We are not able to refund monies paid to us, or any third party acting on our or your behalf, or make compensation or other payments where, for whatever reason, you fail to join the ship. Passengers going ashore are responsible for re-boarding the ship prior to departure from port.

We reserve the right to substitute another vessel for the scheduled vessel whether or not owned or operated by Hurtigruten. Any part of the travel arrangements and the voyage is subject to cancellation, delay, modification, or island/mainland visit cancellation for any reason, including medical disembarkation of crew or passengers or any other circumstances beyond our or our suppliers' control. You therefore acknowledge and agree that the scheduled itinerary for the voyage and the announced departure and arrival times are not guaranteed and we shall not be liable to passengers for any damages

or other claims in the event of any delay, changes in itinerary or inability to perform services by reason of any event or events beyond our or our suppliers' control.

15. INSURANCE

It is a condition of the contract with us that every member of the booking has travel insurance in force for the entire duration of the booking, covering at least the cancellation of the booking and providing medical cover for illness or injury and repatriation while overseas. Please provide us with the name of your insurer, together with their 24-hour emergency number when you book or as soon as possible.

16. TIMINGS, DELAYS & OTHER TRAVEL INFORMATION

Timings are estimates only and cannot be guaranteed, even if shown on tickets. They may be changed due to regulatory authority requirements, weather conditions, maintenance or technical reasons, and the ability of passengers to check in and board on time. Sometimes delays cannot be avoided but in such situations, in conjunction with our local agents or representatives, we will try to ensure your comfort during the course of any delay.

Where the port of embarkation is in the EU and the company reasonably expects the departure of a cruise to be delayed for more than 90 minutes beyond its scheduled departure time, passengers departing from port terminal shall be offered free of charge snacks, meals or refreshments as are appropriate given the waiting time, provided they are available and can reasonably be supplied. If the delay in departure necessitates a stay of one or more nights or a stay additional to that intended by the passenger where and when physically possible the Company shall, subject to the Package Travel Regulations 1992 and the EU Directive 2015/2302 on Package Travel (and subsequent UK regulations, offer passengers departing from port terminals free of charge adequate accommodation on board or ashore, and transport to and from the port terminal and place of accommodation in addition to the snacks, meals and refreshments previously referred to. The maximum amount that the company will pay for accommodation ashore and transport to and from the port terminal shall be equivalent to 80 Euros per person per night for a maximum of three nights. The company will not have an obligation to provide such accommodation ashore where the delay is caused by weather conditions endangering the safe operation of the ship.

Please note the existence of a "Community list" (available for inspection at https://ec.europa.eu/transport/modes/air/safety/air-ban_en) detailing air carriers that are subject to an operating ban with the EU Community.

17. PROMPT ASSISTANCE

If the contract we have with you is not performed or is improperly performed as a result of failures attributable to you or a third party unconnected with the provision of the arrangements, or as a result of failures due to unusual and extraordinary circumstances, and you suffer an injury or other material loss, we will offer you such prompt assistance as is appropriate in the circumstances. In particular, we will provide you with appropriate information on health services, local authorities and consular assistance, and with distance

communications and finding alternative travel arrangements.

Where you experience a delay which is not owing to any failure by us, our employees or sub-contractors, this prompt assistance is likely to extend to providing help in locating refreshments, accommodation and communications but not paying for them. Any airline or other transport supplier may however pay for or provide refreshments and/or appropriate accommodation and you should make a claim directly to them. Subject to the other terms of these conditions, we will not be liable for any costs, fees or charges you incur in the above circumstances, if you fail to obtain our prior authorisation before making your own travel arrangements.

18. VALIDITY OF TERMS AND CONDITIONS

These terms and conditions are valid from March 2025 and the details and prices may be superseded. Changes may occur after the date of release, and some hotel/ship facilities may become unavailable. While this brochure features photography and descriptions of local wildlife, there is no guarantee of sightings.

19. LAW AND JURISDICTION

Your contract shall be governed by English law and the jurisdiction of the English Courts. You may however choose the law and jurisdiction of Scotland or Northern Ireland if you wish to do so.

20. DATA PROTECTION

In order to process your booking and ensure your travel arrangements run smoothly and meet your requirements we, Hurtigruten Ltd, need to use the information you provide such as name, address, any special needs/dietary requirements etc. We take full responsibility for ensuring that proper security measures are in place to protect your information. We must pass the information on to the relevant suppliers of your travel arrangements such as airlines, ships, hotels, transport companies etc. The information may also be provided to security or credit checking companies, public authorities such as customs/immigration if required by them, or as required by law.

Additionally, where your holiday is outside the European Economic Area (EEA), controls on data protection in your destination may not be as strong as the legal requirements in this country. We will not pass any information on to any person not responsible for part of your travel arrangements. This applies to any sensitive information that you give to us such as details of any disabilities, or dietary/religious requirements. (If we cannot pass this information to the relevant suppliers, whether in the EEA or not, we cannot provide your booking. In making this booking, you consent to this information being passed on to the relevant persons.) Please note that where information is also held by your travel agent, this is subject to your agent's own data protection policy. Hurtigruten is not responsible for the privacy practices of any other companies.

Please see our website for the latest terms and conditions: www.hurtigruten.com/en-gb/practical-information/general-terms-and-conditions

Date: March 2025

1893 Ambassadors

Sign up to our free loyalty
programme and look forward to:

Welcome gift in your cabin

Complimentary Wi-Fi

5% discount on excursions

Discounts with a range of partners including
10% with Helly Hansen



1893 Ambassadors

COVER: © KRISTIAN DALE; THIS PAGE: © LIGHTSCAPE / UNSPLASH



Reservations 0203 131 3218
Email uk.sales@hurtigruten.com
Web hurtigruten.com



@HurtigrutenUK



@hurtigruten



@hurtigruten